

# The Lagrangian Ensemble Recruitment Model LERM

LERM is an individual-based food-chain model with  
2 nutrients, 3 plankton trophic levels & 2 top predators

N – Si – P – Zh – Zc – TP1 – TP2 – D

**Matteo Sinerchia, Silvana Vallerga, John Woods**

Virtual Ecology Research Group

Department of Earth Science & Engineering

Imperial College London

2008

<http://www.virtualecology.org>

## Contents

INTRODUCTION .....	8
Introduction to LERM.....	9
Principal features of LERM.....	10
Lagrangian Ensemble modelling .....	11
Separation of endogenous and exogenous properties .....	11
The model .....	12
Virtual mesocosm .....	13
Initial conditions .....	14
Boundary conditions .....	15
Top predators .....	16
The Virtual Ecology Workbench (VEW 3.3) .....	17
LERM on VEW 3.3.....	17
Phenotypic equations and rules .....	18
Creation of the Virtual Plankton Ecosystem .....	19
Chemicals.....	20
Biochemistry .....	21
Staged growth .....	22
Physics.....	23
Optics .....	23
Turbocline .....	23
Particle movement.....	24
<hr/>	
PART 1 – Phytoplankton .....	25
Design considerations .....	26
Physics.....	26
Diatoms .....	26
Nitrogen.....	26
Silicon.....	27
Carbon.....	27
Limiting nutrients.....	28
Primary production above the nutriclines .....	28
Motility .....	28
Overview for Phytoplankton.....	29
State variables .....	30
Parameters .....	31
Chemical pools in a diatom .....	33
Biological rules .....	34
1. Effect of temperature.....	35

2. Photosynthesis .....	36
3. Chlorophyll synthesis .....	40
4. Respiration .....	42
5. Cell division .....	44
6. Nutrients uptake.....	46
7. Update pools .....	54
8. Mortality (natural mortality).....	56
9. Motility .....	58
10. Excretion .....	59
11. Remineralization .....	60
12. Calculating the Geider quotas .....	63
<hr/>	
<b>PART 2 – Herbivorous zooplankton .....</b>	<b>64</b>
<b>Design considerations .....</b>	<b>66</b>
Choice of species .....	66
Staged growth.....	66
Copepod size .....	66
Swimming speed .....	67
Behaviour .....	67
Risk of being eaten .....	67
Droop pools.....	67
Respiration .....	67
Starvation .....	67
Cannibalism .....	68
Gut passage time.....	68
Digestion .....	68
Egestion .....	68
Excretion .....	68
Grazing.....	68
Satiation .....	69
Adaptive behaviour .....	69
Diel migration .....	69
Diapause .....	70
Foraging .....	70
Reproduction.....	70
Senility.....	70
<b>Overview for Herbivores .....</b>	<b>71</b>
<b>State variables for Herbivores .....</b>	<b>72</b>
<b>Parameters for Herbivores .....</b>	<b>73</b>
<b>Chemical pools for Herbivores .....</b>	<b>75</b>
<b>Staged growth for Herbivores.....</b>	<b>76</b>
<b>Biological rules for Herbivores.....</b>	<b>77</b>
1. Copepod size.....	77
2. Effect of temperature and size on copepod swimming speed .....	80

3. Diel migration.....	81
4. Foraging .....	83
5. Swimming direction.....	85
6. Migration during diapause .....	86
7a. Migration out of diapause for OWA4.....	87
7b. Migration out of diapause for OWA5.....	88
8. Motility .....	89
9. Sinking of corpses.....	90
10. Gut volume .....	91
11. Respiration: basal metabolic cost.....	93
12. Respiration: Swimming cost .....	94
13a. Preparing for diapause as OW4.....	96
13b. Preparing for diapause as OW5.....	97
14. Preparing for diapause as C4OW .....	98
15a. Starting diapause as POW4 .....	99
15b. Starting diapause as POW5 .....	99
16a. Diapause OW4.....	100
16b. Diapause OW5.....	100
17. Ingestion.....	102
18. N specific assimilation efficiency .....	106
19. Egestion .....	107
20. Fæcal pellet.....	108
21. Assimilation of ammonium.....	111
22. Respiration: specific dynamic action cost.....	112
23. Energetics.....	113
24. Energetics during diapause .....	114
25a. Start descent to diapause for OWD4 .....	115
25b. Start descent to diapause for OWD5 .....	116
26. Become adult.....	117
27. Become mature .....	117
28. Naupliar mortality counter .....	117
29. Pellet sinking.....	118
30a. Turn POW4 into C4OW.....	119
30b. Turn POW5 into C5.....	119
31. Update gut content.....	119
32. Update depth .....	120
33. Allocation of assimilated carbon .....	121

33a. Allocation of carbon to storage 1 .....	123
33b. Allocation of carbon to storage 2 .....	123
33c. Allocation of carbon storage 3 .....	123
33d. Allocation of carbon to carapace.....	123
34. Lipid pool .....	124
35. Protein pool .....	125
36. Carapace C pool.....	126
37. Total carbon.....	126
38. Ammonium pool.....	126
39. Nitrate pool .....	127
40. Total nitrogen.....	127
41. Silicate pool .....	127
42. Reproduction .....	128
43. Eggs production.....	130
44. Naupliar mortality.....	131
45. Metamorphosis of N3, N4, N5 .....	131
46. Metamorphosis of N6, C1, C2 .....	131
47. Metamorphosis of C5.....	131
48. Mortality due to starvation .....	132
49. Mortality due to senescence.....	132
50. Excretion.....	133
51. Remineralisation .....	134
<hr/>	
<b>PART 3 – Carnivorous zooplankton .....</b>	<b>136</b>
<b>Design considerations .....</b>	<b>137</b>
Planktonic squid.....	137
Other carnivores in LERM.....	137
Staged growth.....	137
Squid growth.....	138
Behaviour.....	138
Feeding .....	138
Food demand.....	138
Gut processes.....	139
Reproduction.....	139
Inter-annual variation.....	139
<b>Overview of Carnivores .....</b>	<b>140</b>
<b>State variables for Carnivores .....</b>	<b>141</b>
<b>Parameters for Carnivores .....</b>	<b>142</b>
<b>Chemical pools for Carnivores .....</b>	<b>144</b>

Stages of Carnivores .....	145
Biological rules for Carnivores.....	146
1. Spawning.....	148
2. Embryogenesis .....	149
3. Physiological state at hatching .....	151
4. Time since hatching .....	158
5. Growth rate.....	159
6. Effect of size and temperature on swimming speed .....	160
7. Diel migration.....	161
8. Foraging .....	163
9. Swimming direction.....	165
10. Motility .....	166
11. Sinking of corpses.....	166
12. Ingestion.....	167
13. Digestion .....	170
14. Assimilation .....	173
15. Gut volume .....	176
16. Respiration: basal metabolic cost.....	177
17. Respiration: specific dynamic action cost.....	178
18. Respiration: cost of swimming.....	179
19. Energetics.....	182
20. Update gut content.....	184
21. Depth of egg mass .....	188
22. Update depth .....	188
24. Update yolk pool .....	190
25. Update lipid.....	191
26. Update protein .....	193
27. Total carbon.....	194
28. Weight .....	194
29. Mantle length .....	195
30. Update nitrogen pool.....	196
31. Mortality due to starvation .....	197
33. Excretion .....	199
34. Egestion .....	200
35. Pellet sinking.....	201
36. Pellet remineralisation.....	202
37. Metamorphosis from $S_j$ to $S_{(j+1)}$ .....	203

38. Recruits N release .....	204
39. N adjustment.....	205
<hr/>	
<b>PART 4 – Top Predators .....</b>	<b>207</b>
<b>Design considerations .....</b>	<b>208</b>
Computer agents for top predators.....	208
Predation.....	208
Feeding .....	208
Top predator growth .....	208
Top predator excretion and egestion.....	208
Demography .....	209
Top predator motility.....	209
Trophic closure .....	209
<b>Overview of Top Predators.....</b>	<b>211</b>
<b>Exogenous rules for Top Predator (s) .....</b>	<b>213</b>
1. Total concentration of TP (s) .....	213
2. Vertical distribution of TP(s) .....	213
3. Size of TP(s).....	214
<b>Endogenous rules for TP(s).....</b>	<b>215</b>
4. Ingestion for TP(s) .....	215
5. Egestion for TP(s).....	219
6. Pellet sinking for TP(s).....	220
7. Remineralisation for TP(s).....	221
<b>Exogenous rules for Top Predator (c) .....</b>	<b>222</b>
1. Total concentration of TP(c) .....	222
2. Vertical distribution of TP(c) .....	222
3. Size of TP(c).....	222
<b>Endogenous rules for TP(c).....</b>	<b>223</b>
4. Ingestion for TP(c) .....	223
5. Egestion for TP(c).....	226
6. Pellet sinking for TP(c).....	226
7. Remineralisation for TP(c).....	227

# INTRODUCTION

Introduction to LERM.....	9
Principal features of LERM.....	10
Lagrangian Ensemble modelling .....	11
Separation of endogenous and exogenous properties .....	11
The model .....	12
Virtual mesocosm .....	13
Initial conditions .....	14
Boundary conditions .....	15
Top predators .....	16
The Virtual Ecology Workbench (VEW 3.3) .....	17
LERM on VEW 3.3.....	17
Phenotypic equations and rules .....	18
Creation of the Virtual Plankton Ecosystem .....	19
Chemicals.....	20
Biochemistry .....	21
Staged growth .....	22
Physics.....	23
Optics .....	23
Turbocline .....	23
Particle movement.....	24



## Introduction to LERM

This technical report documents the Lagrangian Ensemble Recruitment Model (LERM). It is based on Matteo Sinerchia's PhD thesis, which can be downloaded from <http://www.virtualecology.org>. LERM replaces WB as the baseline model for research in the Virtual Plankton Ecology research group at Imperial College.

---

LERM is an individual-based model designed to be integrated under the Lagrangian Ensemble metamodel which creates virtual ecosystems. It was created on the Virtual Ecology Workbench (download Handbook VEW 3.3 from <http://www.virtualecology.org> ).

The model uses phenotypic equations for all biological functions, including the physiology and behaviour of individual plankters. These equations were derived from the scientific literature. They are based mainly on reproducible experiments performed by marine biologists under controlled conditions. They are therefore as soundly based as the equations for physical and chemical processes used in combination with LERM to create virtual ecosystems.

## Principal features of LERM

1. Two nutrients that can limit phytoplankton reproduction
  - a. Nitrogen in the form of nitrate and ammonium
  - b. Silicon in the form of silicate used to make diatom shell
  
2. Phytoplankton are diatoms featuring:
  - a. Geider's equations for photo-adaptation
  - b. Dynamic chlorophyll concentration controlled by nitrogen uptake
  - c. Silicate uptake just prior to cell division.
  
3. Herbivorous zooplankton based on calanoid copepods featuring:
  - a. Carbon in three forms: proteins, lipids and chitin
  - b. Staged growth following Carlotti and Wolf
  - c. Diel migration
  - d. Seasonal migration (diapause).
  - e. Egestion of faecal pellets
  - f. Visibility determines the risk of being eaten by squid
  
4. Carnivorous zooplankton based on planktonic squid (*Loligo*)
  - a. Feed visually on the copepods.
  - b. Initialized each year by an (exogenous) spawning event
  - c. Emigration from the virtual ecosystem after attaining a critical size
  
5. A top predator that also feeds on the copepods
  
6. A second top predator that feeds visually on the planktonic squid
  
7. Detritus comprising dead plankton and faecal pellets.

## Lagrangian Ensemble modelling

### *Separation of endogenous and exogenous properties*

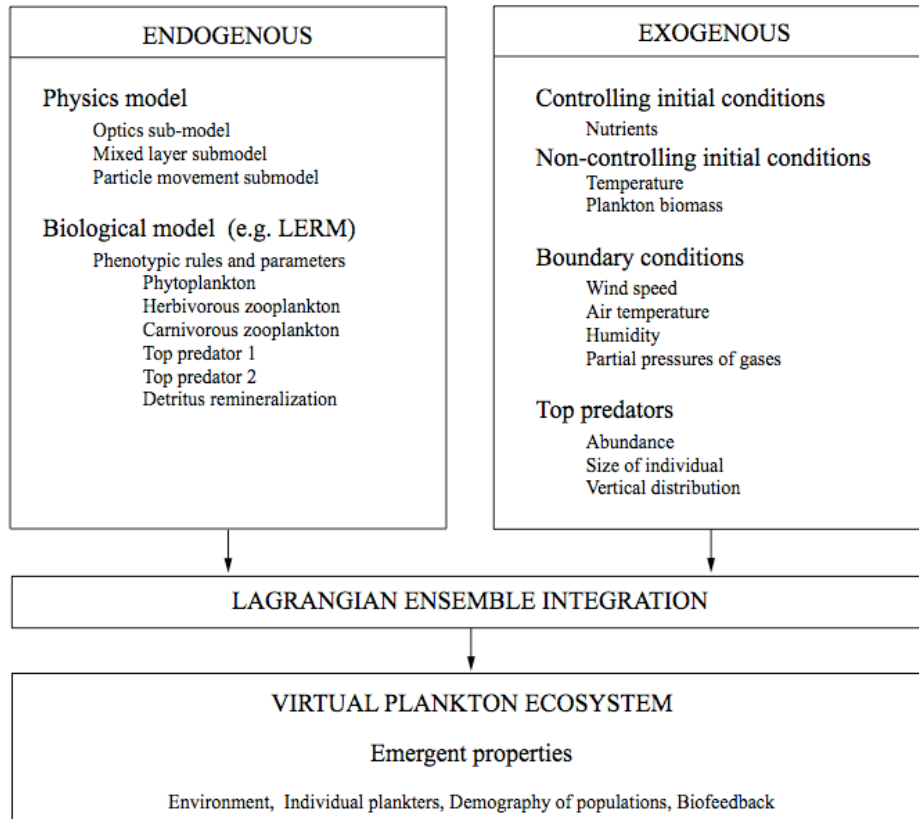

Fig.1. Separation of endogenous and exogenous properties in LE modelling.

The endogenous and exogenous functions are formally separated in LE modelling<sup>1</sup>. That makes LE codes easy to create and maintain. The modularity is strictly enforced by VEW 3.3 which automatically checks internal consistency as a model is being created or modified. This eliminates the need to debug LE code.

The *endogenous* functions and properties determine how the environment and plankton respond to external forcing and to internal (endogenous) feedback. The endogenous functions are described by rules and parameters. Together they make up a model, which has two parts, (a) physical and (b) biological.

The *exogenous* functions and properties are defined as being those that are not affected by feedback from the ecosystem. They are often described as what “forces” the virtual ecosystem. They include the solar elevation, weather, ocean circulation, nutrients, top predators and events such as spawning. The exogenous functions and properties provide the initial and boundary conditions when the model is integrated to create the virtual ecosystem.

<sup>1</sup> They tend to get tangled up in classical codes for plankton ecosystem modelling.

LE codes also formally separate the internal functions of the (endogenous) model and (exogenous) forcing respectively.

### ***The model***

The endogenous functions can be divided into two classes, physical and biological.

1. The *physical* functions control the physical environment, including the vertical profiles of the spectrum of sunlight, turbulence and temperature. Each function includes two factors: (exogenous) forcing and (endogenous) feedback from the plankton. There are three physical functions.

They are represented by physical sub-models:

- a. an *optical submodel* is used to compute the vertical distribution of solar irradiance in each of 23 wavebands. The computation takes account of solar elevation (exogenous) and seawater turbidity (an emergent property of the virtual ecosystem).
  - b. a *mixed layer submodel* is used to compute the depth of the turbocline and the turbulent kinetic energy in the mixing layer above the turbocline. The computation takes account of the exogenous factors (solar elevation, cloud-cover, wind-stress and oceanic cooling to the atmosphere, computed from wind speed, air temperature and humidity) and sea surface temperature (an emergent property of the virtual ecosystem). The model includes no vertical diffusion in the diurnal, seasonal and permanent thermoclines, on the grounds that the flow has been observed to be mainly laminar there<sup>2</sup>.
  - c. a *particle displacement submodel* is used to compute the trajectories of individual plankters and detritus (dead plankters and faecal pellets), taking into account turbulence (if above the turbocline) and plankter motility (i.e. its motion relative to the water due to sinking or swimming).
2. The *biological* functions control an individual plankter's response to its ambient environment, defined as the physical, chemical and biological profiles at its location (they are all emergent properties of the virtual ecosystem). The biological functions are represented by phenotypic rules<sup>3</sup> and parameters. The phenotypic rules and parameters of LERM are documented in Part II below.

---

<sup>2</sup> Vertical diffusion in the thermocline can also be justified as parametrizing the vertical transport of scalars effected by transient up- and down-welling due to mesoscale turbulence, but this is not featured in the current version of LE modelling. In any case measurements show that it is small (order 1 mm<sup>2</sup>/s) compared with values favoured by ecological modelers.

<sup>3</sup> V.Grimm & S.F.Railsback *Individual-based modeling and ecology* Princeton Univ.Press, 428pp 2005

## ***Virtual mesocosm***

Integrating the model creates a one-dimensional virtual ecosystem<sup>4</sup>. This lies in a virtual mesocosm, which has the form of a tube with a vertical axis, extending from the sea surface down to a depth of (typically) one kilometre. The area of the horizontal cross-section is typically one square metre. The emergent properties of the virtual ecosystem in this mesocosm represent those in a much larger area, typically one degree of latitude and longitude (roughly one hundred km square), which is the resolution of the exogenous forcing. The units of vertically-integrated environmental and demographic properties in a one-dimensional model have the form “Value per square metre”.

The present release of the VEW can only work with a virtual mesocosm in the open ocean where the seabed is much deeper than the base of the mesocosm. The bottom boundary condition for the virtual mesocosm is open: particles drop through it unhindered into the deep ocean below<sup>5</sup>.

The mesocosm can be anchored at a fixed geographical location, or it can drift with the ocean circulation. The latter procedure called *Geographically Lagrangian Integration* is supported by VEW 3.3. LERM works with either fixed or drifting mesocosms.

---

<sup>4</sup> A future release of the VEW will generate a three-dimensional virtual ecosystem in a virtual mesocosm. A prototype fits the 3D virtual ecosystem into an open ocean virtual mesocosm with dimensions of 100km x 100km. The environmental fields in the mesocosm are defined by a 3D mesh. Each plankter follows a trajectory defined every time step by its position ( $\pm 1$ mm) in that 3D space. This 3D virtual ecosystem is designed to simulate the response of the plankton ecosystem to mesoscale turbulence, which is missing from the one-dimensional virtual ecosystems described in this report.

<sup>5</sup> We plan to create a new version of the VEW that can generate virtual ecosystems in shallow water. This will require upgrading the physical and biological models to include seabed processes. They are not included in LERM.

## ***Initial conditions***

The initial conditions are used when integrating the model to create a Virtual Ecosystem. There are two classes of initial conditions: controlling and non-controlling (see Figure 1).

1. The *controlling initial conditions* are exogenous properties that provide the essential resources for the virtual ecosystem. In the case of LERM they are the nutrients: nitrate and silicate<sup>6</sup>. The emergent properties of the virtual ecosystem are controlled by the concentrations (mass per square metre) of these nutrients in the seasonal boundary layer (i.e. between the sea surface and the annual maximum depth of the turbocline).
2. The *non-controlling initial conditions* include vertical profiles of the physical environment (temperature, solar irradiance and turbulence) and vertical profiles of the biological environment (biomass of each species of plankton in the model). These exogenous properties are needed to start the computation, but they are forgotten after a few years when the virtual ecosystem has adjusted to an attractor. Once on attractor, the emergent properties of the virtual ecosystem depend only on the model and the boundary conditions. They no longer depend on the values of the *non-controlling* initial conditions.

---

<sup>6</sup> The concentration profile of ammonium concentration in the seawater is initially zero. It is an emergent property of the virtual ecosystem. It is therefore an endogenous variable.

## ***Boundary conditions***

The boundary conditions describe the fluxes through the boundaries of the *virtual mesocosm*, which contains the one-dimensional virtual ecosystem. The horizontal resolution of the (exogenous) weather data used to compute the boundary conditions at the sea surface is usually one degree of latitude and longitude (order 100km square). The horizontal resolution of the velocity vector array used to represent the ocean circulation in geographically-Lagrangian integration is one quarter of a degree of latitude and longitude.

The boundary conditions are used to compute:

1. the vertical fluxes through the (horizontal) upper boundary of the mesocosm located at the sea surface. They include solar radiation, momentum, heat, water vapour and other gases. They are computed using equations that take account of exogenous properties (solar elevation, cloud cover, wind speed, air temperature and humidity, and the concentrations of gases in the atmosphere), plus emergent properties of the virtual ecosystem at the top of the mesocosm.
2. the vertical fluxes through the horizontal lower boundary located at a depth of (typically) 500m. They are computed using an advection equation that takes account of exogenous upwelling (if any).
3. the horizontal fluxes through the vertical sidewall. They are usually assumed to produce zero horizontal divergence in all properties of the virtual ecosystem. This is equivalent to assuming that advection by the ocean circulation does not influence the virtual ecosystem. The error in that assumption can be reduced substantially by using geographically-Lagrangian integration.

### ***Top predators***

The top predators in LERM are plankton species that have ingestion and egestion equations like those of the endogenous zooplankton. But they have no equation for behaviour, so an exogenous TP equation is used to compute the changing vertical distribution of each top predator species. Other exogenous equations are used to compute the changing size of individual top predators and their number density. These *top predator equations* are functions of exogenous properties only; they do not depend on emergent properties of the virtual ecosystem. In particular they do not depend on the rate at which the top predators ingest their prey.



## **The Virtual Ecology Workbench (VEW 3.3)**

The LERM model was created on VEW 3.3, which automatically generates an executable Java code from phenotypic rules entered in familiar form using an equation editor. VEW 3.3 also provides a database manager for entering parameter values.

The VEW 3.3 Handbook can be downloaded from  
<http://www.virtualecology.org>.

As was mentioned above, the biological model (LERM in this case) is only one part of the specification needed to create a virtual ecosystem under the Lagrangian Ensemble (LE) metamodel. The other parts are the physical model and the exogenous processes and properties. When the user has specified all these components, the VEW automatically initiates their integration to create the virtual ecosystem.

### ***LERM on VEW 3.3***

LERM was originally written as the biological model for the Imperial College fisheries recruitment project (Sinerchia, 2007). However it can usefully serve as a base for other projects. In that case you will normally need to change some phenotypic equations or parameter values, or to add new ones. Such changes are easily made using the Equation editor on VEW 3.3.

This technical documentation of LERM has been written in a style that will facilitate this processing of editing the LERM model. Each phenotypic rule is presented in a box, using nomenclature that you will see in the corresponding box when viewing LERM on VEW 3.3.

The conventions used in the VEW 3.3 Equation Editor are internally consistent and designed to ensure that each equation (= phenotypic rule) obeys the LE metamodel.

There will be no bugs in the Java code which is compiled from the XML code written by the VEW 3.3 Equation Editor.

### ***Phenotypic equations and rules***

The VEW 3.3 rule editor is designed to ensure that phenotypic rules used to describe biological functions of an individual plankter in a model such as LERM are entered in a form that is consistent with the Lagrangian Ensemble metamodel. The phenotypic rule is normally expressed in the following way:

$\text{value of the variable at the next time step (t)}$
$= \text{a function of the values of variables at the end of the last time step (t-1).}$

This updates the biochemical state of one individual plankter, or its new position if the biological function concerns behaviour (i.e. movement relative to the water).

It is usual to refer to this as a “rule” rather than an “equation”. So a phenotypic equation found in the marine biology literature is translated into a finite-difference rule for the LE biological model.

The LERM rules documented below are presented in this way. They have precisely the form that you will see if you examine LERM on the graphical user interface of VEW 3.3.

The biological model (LERM) comprises hundreds of phenotypic rules entered using the VEW Equation Editor. They can be entered in any order. The particular order they appear in this documentation of LERM follows what you will find on the VEW when you examine LERM.

The ability to enter the phenotypic rules in any order is a benefit of the two-stage procedure followed by the VEW when it is instructed to run a job. See fig. 2. The first stage creates a small piece of XML code for each phenotypic rule. All those pieces of XML code with others from the Scenario (for exogenous factors) go into a basket. They do not have any particular sequence in that basket. The second (compile) stage creates an executable Java code from that basket of XML codelets. The Java code is the integrated on a computer to produce the Virtual Plankton Ecosystem.

### Creation of the Virtual Plankton Ecosystem

The VEW 3.3 follows a two-stage procedure when instructed to run a job. The process is illustrated in the following Figure 2.

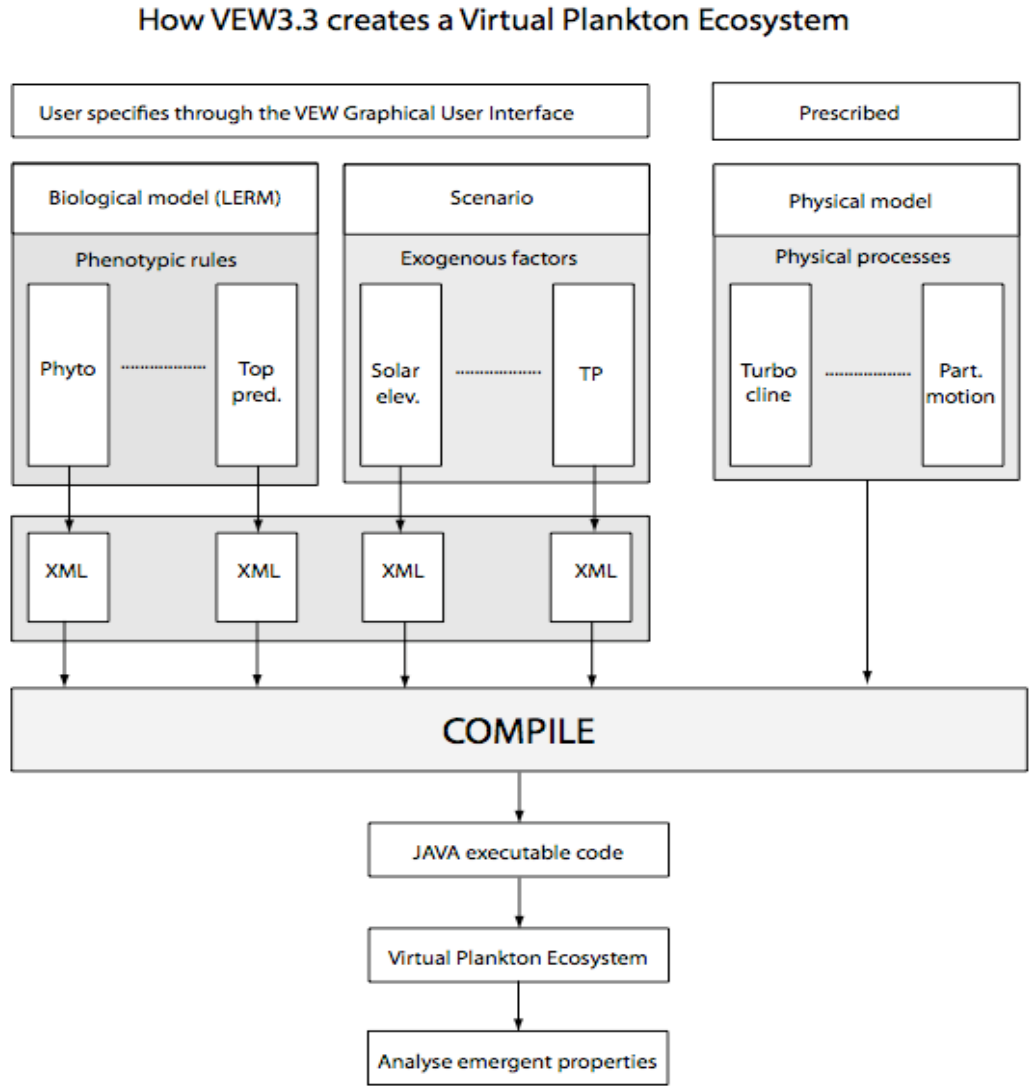

Fig. 2 Procedure followed by the VEW when instructed to run a job

## **Chemicals**

The biological state of a plankter is defined by two properties: (1) its growth stage and (2) a set of chemical (Droop) pools.

VEW 3.3 automatically computes the budgets of all chemicals specified in a biological model such as LERM. The budgeting takes account of chemicals changing between dissolved and particulate forms. And it takes account of changes in the mass of chemical in each Droop pool in every plankter in the virtual ecosystem, and dissolved in the seawater.

To budget the chemicals it monitors changes each time step due to uptake of nutrients by phytoplankton, their ingestion by herbivores, and subsequently by carnivores and then top predators. Furthermore, it monitors the transfer of chemicals into faecal pellets and into the corpses of dead plankters. The budgeting involves computation of the depletion of dissolved chemicals in the seawater, and their re-introduction by bacterial action on detritus i.e. the remineralization of chemicals from faecal pellets and into the corpses of dead plankters.

This powerful feature of VEW 3.3 performs chemical budgeting at the molecular (or ionic) level such as nitrate, ammonium and chlorophyll. Whenever the model designer specifies a new chemical, VEW 3.3 automatically creates its concentration profile in the seawater, and a Droop pool for the chemical in every particle, whether living or dead plankter, or a faecal pellet. In a particular model (e.g. in LERM) the concentration of a chemical in solution and in some particles may be declared always to be zero. And while VEW 3.3 automatically creates a chlorophyll pool in every individual plankter, the mass of it remains zero in all LERM zooplankton. And the concentration of chlorophyll in solution is specified in the model always to be zero.

VEW 3.3 manages all chemical masses in moles. As a reminder, this documents provides the conversion factors between mole and grams. Solar irradiances are managed in Einstein  $\text{s}^{-1} \text{m}^{-2}$  (for photosynthesis) or in Watt  $\text{m}^{-2}$  (for the physical environment); conversion factors are provided.

VEW 3.3 does not budget chemicals at the atomic level. It is unaware of the atomic compositions of the chemicals that it monitors and budgets. Nor does VEW 3.3 handle chemical formulae, such as those needed to compute the pools of protein and lipid created inside a zooplankter. Chemical budgeting at the atomic level, and biochemical processes occurring inside a plankter must be managed explicitly by user equations (rules) in a biological model. You will find examples in this documentation of LERM.

## **Biochemistry**

VEW 3.3 includes a feature that allows the modeler to write equations for biochemical processes occurring inside a plankter. For examples it allows the modeler to specify how much of the carbon in a diatom ingested by a copepod will be allocated to the herbivores pools for lipid, protein and chitin. In LERM it is assumed that this allocation occurs within the same time step as diatoms was ingested; but VEW 3.3 permits the modeler to specify a slower process.

VEW 3.3 uses a special “transfer pool” to facilitate this allocation of chemicals from the form in solution or in the prey to other forms in the predator. Transfer pools are created automatically by the VEW whenever the modeler introduces a phenotypic rule for either chemical uptake from the seawater (by phytoplankton) or the ingestion of a prey by a predator. The VEW creates one transfer pool for every chemical taken up from seawater or ingested from prey. With one exception a transfer pool is like any other chemical pool. It occurs in solution (usually, but not necessarily, with a zero value) and in every plankter, whether living or dead, and in every faecal pellet.

The exception is that the modeler may not write an equation for the updating of a transfer pool. At the end of each time step the VEW automatically zeroes every transfer pool. It is up to the modeler to write phenotypic rules for the transfer of chemical in the transfer pool to other pools in the plankter. In the example presented above, when the copepod eats a diatom, the ingested organic carbon is allocated first to the organic carbon transfer pool in the copepod. The carbon in the transfer pool is then allocated to the lipid, protein and chitin pools in the specified proportions. In the case of ingested nitrogen, the transfer may involve a proportion being egested in a faecal pellet or excreted to the seawater as ammonia.

As was noted before, VEW 3.3 does not support chemical reactions and the budgeting of elements in the declared chemicals. However, the transfer pools and associated allocation rules goes a long way to permitting biochemical functions in the plankton.

## ***Staged growth***

VEW 3.3 allows the model designer to specify a number of *biological states* for each plankton functional group. LERM has five functional groups: diatoms, copepods, squid paralarvae, and the two top predators. The portfolio of biological functions is identical for all biological states of a given functional group. But each *biological state* in that group has its own set of parameter values. That allows the user to design a functional group in which each of the functions is switched on or off depending which biological state the plankter is in. That is achieved by allocating to each *biological state* a list of specific values for the parameter used in that functional group.

One obvious application is to define two *biological states*: dead and alive. When the plankter is in the *dead* state many functions are switched off, including ingestion, egestion, excretion, respiration and motility. But other functions are switched on: for example, the “Remineralization rate parameter” which determines how rapidly the chemicals in the dead plankter’s Droop pools are released into solution (i.e. remineralized by attached bacteria); that parameter was set to zero when the plankter was in the *living* state.

Another application of biological states is to manage staged growth. LERM features Carlotti & Wolf’s prescription for staged growth in the copepods. The model includes criteria that determine when an individual copepod will metamorphose from its current stage to the next.

Defining growth stages also permits the user to design a model in which a predator species can select particular growth stages in its prey. It can even choose to eat only dead prey.

When a zooplankter egests a faecal pellet, VEW 3.3 allocates a new computer agent to the pellet, so that it follows a trajectory that is independent of the zooplankter that made it. The faecal pellet is deemed to be in the same functional group as the zooplankton that made it. That is achieved by defining a new biological state that is neither alive (in one of the growth stages) or dead: it is a faecal pellet. That is achieved by setting to zero all the parameters for that functional group, with the exception of those relevant to the faecal pellet: for example, its sinking speed, and the rate at which attached bacteria remineralize the chemicals in its Droop pools.

## **Physics**

VEW 3.3 does not permit the user to change the physical model. We plan to open up the physical model in a future version of the VEW. The user will then be able to change the physical equations and parameters. Meanwhile they are locked inside the VEW code. That embedded physical model is documented in Woods (2005).

The physical model is not part of LERM, which deals only with biological processes. However, there follows a succinct commentary on the physical model. As noted above, it has three sub-models for optics, turbocline and particle movement, respectively.

## **Optics**

The optics model is used to compute the profile of solar irradiance in each of a set of 23 wavebands extending from UV to IR. Twelve of the wavebands occur in the Photosynthetically Active Range (PAR, 400-700nm). This allows the biological modeller to specify action spectra for pigments used in photosynthesis and vision.

The profile of solar heating is computed from the flux divergence of solar irradiance. This is used to calculate the diurnal variation of buoyant convection and therefore of the turbocline depth, which is critically important for the virtual ecosystem. Accurate computation of diurnal variation in turbocline depth can only be achieved with high spectral resolution in the optical model. (Unacceptable errors result from using only two or three wavebands, a common practice in past ecological modelling.)

## **Turbocline**

Turbulent mixing layer extends down from the sea surface to the turbocline, below which the flow is laminar. Two processes control the depth of the turbocline: convection and turbulent entrainment.

The depth of buoyant convection depends on three factors: (a) the rate at which the ocean loses heat to the atmosphere, (b) the temperature profile, and (c) the profile of solar heating. This is the dominant process controlling the depth of the turbocline. The solar heating term produces the diurnal variation in turbocline depth.

The computation of turbocline depth proceeds in steps, starting with solar heating, then buoyant convection, and finally turbulent entrainment. The depth of convection provides a good first-order prediction of turbocline depth. Turbulent entrainment slightly deepens the turbocline as predicted by convection alone. The magnitude of that deepening depends on the temperature profile that is left after the convection stage, and the power input to turbulent kinetic energy from two sources: the work done by the wind against the friction of the sea surface, and the release of gravitational potential energy by the upward heat flux supplying heat loss to the atmosphere.

The step-by-step computation of turbocline depth is a unique feature of the mixed layer model of Woods & Barkmann (1986), which is used in VEW 3.3. It alone yields the accuracy required for computation of the diurnal and seasonal

variations in turbocline depth, which are critical for the virtual ecosystem. Older methods in which all the processes are bundled into a turbulent diffusion equation (with appropriate choice of turbulent closure) do not simulate the diurnal variation of turbocline depth accurately enough for individual-based modelling of the plankton ecosystem.

### **Particle movement**

One of the most important tasks of the physics model is to compute the trajectory of particles, including individual living plankters, the corpses of dead plankters and faecal pellets. The change of depth of a particle from one time step to the next depends on two processes: (1) advection with the water, and (2) movement through or relative to the water, due to the particle's sinking or swimming. The displacements of a particle by these two processes are computed in that order.

Advection with the water is computed in two steps. The first is a vertical displacement due to up- or down-welling. The second is random displacement by turbulence. The latter only applies above the turbocline.

The random displacement by turbulence leads to the dispersion of particles, so they follow different trajectories. Each trajectory determines the particle's biological development. So the turbulent dispersal of plankton trajectories, leads to intra-population variation in plankton histories. That affects a population's demographic history and the bio-feedback it produces in the environment.

After computing the displacement by advection, the physics model computes the change in depth due to sinking or swimming. In LERM the diatoms, dead plankton of all species, and faecal pellets all sink through the water at a constant speed. Living copepods and squid paralarvae swim up or down following phenotypic rules for foraging and diel and winter migration.



## PART 1 – Phytoplankton

Design considerations .....	26
Physics .....	26
Diatoms .....	26
Nitrogen.....	26
Silicon.....	27
Carbon.....	27
Limiting nutrients.....	28
Primary production above the nutriclines .....	28
Motility .....	28
Overview for Phytoplankton.....	29
State variables .....	30
Parameters .....	31
Chemical pools in a diatom .....	33
Biological rules .....	34
1. Effect of temperature.....	35
2. Photosynthesis .....	36
3. Chlorophyll synthesis .....	40
4. Respiration .....	42
5. Cell division .....	44
6. Nutrients uptake.....	46
7. Update pools .....	54
8. Mortality (natural mortality).....	56
9. Motility .....	58
10. Excretion .....	59
11. Remineralization .....	60
12. Calculating the Geider quotas .....	63

## Design considerations

The role of the phytoplankton in LERM is to nourish the copepods, ensuring that they provide ample food for the squid. The requirement is that most of the copepods graze well enough to reproduce before the squid-spawning event in May. By then the phytoplankton have consumed the nutrients in the mixed layer and continue to reproduce mainly below the nutricline in the seasonal thermocline, at the deep chlorophyll maximum.

### Physics

The first challenge was to ensure a realistic transition from the weak primary production in the deep winter mixed layer (due to the Woods-Onken effect in the winter diurnal thermocline), to the spring bloom (with realistic self-shading), through to seasonal oligotrophy and the formation of the deep chlorophyll maximum below the nutricline. Woods (2005) showed that this sequence was described well by the WB model. That success was largely attributable to the WB physical model, which was embedded in VEW 3.3. Tests showed that the sequence was also described well in LERM virtual ecosystems at the Azores.

### Diatoms

The primary site for numerical experiments on fisheries recruitment was the Atlantic Ocean just north of the Azores. At that site, planktonic squid feed mainly on copepods, which graze on diatoms. This is Cushing's "classical food chain". So the first design decision was to treat all primary production as occurring in a monoculture of diatoms. This followed the representation of phytoplankton in the WB model. We had considerable experience of WB virtual ecosystems at the Azores. The next design decision was to upgrade two aspects of diatom physiology (compared with WB): photo-adaptation and reproduction.

#### *Photo-adaptation*

LERM uses Geider's photo-adaptation equations, in which a dynamic chlorophyll pool in each diatom was controlled by its rate of nitrogen uptake from the seawater. This overcame one of the major shortcomings of WB diatoms: a fixed ratio between carbon, nitrogen and chlorophyll. In LERM the independent pools of nitrogen, carbon and chlorophyll offered greater stoichiometric realism. They also allow us to discriminate between the deep chlorophyll maximum (measured by fluorimeter) and the deep carbon maximum (food for the copepods during the critical weeks leading up to reproduction).

### Nitrogen

LERM budgets nitrogen in two forms: nitrate and ammonium. (The small amount of nitrogen in chlorophyll is not budgeted.) LERM was built on VEW 3.3, which creates Droop pools for all chemicals in every particle (living and dead plankters and faecal pellets). VEW 3.3 also creates a profile for every chemical in solution. LERM diatoms take up both nitrate and ammonium from

solution. They are temporarily stored in the nitrate and ammonium transfer pools in the diatom. Then during the same time step, the contents of both transfer pools are added to the diatom's Droop pool for ammonium. So the ammonium pool stores all the organic nitrogen in the diatom. The diatom's Droop pool for nitrate remains empty throughout the simulation. It has to exist because of VEW 3.3 design, but it never receives any input.

When a diatom is eaten by a copepod, the contents of all its Droop pools are ingested; their contents go initially into the respective transfer pools in the copepod. The contents of the pools are then transferred to the copepod's Droop pools following the phenotypic rules for biochemical processes (see the note on *Biochemistry* on page 21). The Droop pool for ammonium stores all the organic nitrogen in the copepod. And so on when a copepod is eaten by a planktonic squid, and when the squid is eaten by a top predator.

## Silicon

One of the defining features of diatoms is their uptake of silicate from the seawater just before cell division. The silicate is used to build the shell of the new cell. Cell division cannot occur if the seawater is depleted of silicate. So it is a limiting nutrient for primary production in a virtual ecosystem based on diatoms.

When a copepod eats a diatom, it does not ingest the silicate shell. The shell fragments are released into the water, where they are immediately dissolved. This is equivalent to the silicon being excreted immediately after the diatoms have been eaten.

## Carbon

LERM does not feature the seawater carbon chemistry that is found in the WB model, where it was used for the plankton multiplier (Woods & Barkmann 1990). The chemicals declared in LERM do not include inorganic carbon. It would be a simple matter to add it using VEW 3.3, in which case the *dissolved* component (DIC) could be used to compute the partial pressure of dissolved carbon dioxide, as in the plankton multiplier. And every particle would have a Droop pool for inorganic carbon.

That design decision (not to include inorganic carbon) was appropriate for the primary purpose of LERM, computing fisheries recruitment. However, LERM does include organic carbon. VEW 3.3 automatically allocates a Droop pool for organic carbon in every particle, and a profile of dissolved organic carbon (DOC). LERM makes no use of DOC; the profile always has zero concentration at all depths. (Of course, it would be easy to introduce additional rules for DOC chemistry.)

The Droop pool for DOC (called the carbon pool) in a diatom gains carbon from photosynthesis and loses carbon to respiration. When the diatom is eaten by a copepod its DOC is ingested, and placed initially in the copepod's DOC transfer pool. The carbon is then allocated to Droop pools for lipid, protein and chitin (see the design considerations for herbivores in Part 2).

## Limiting nutrients

So LERM has two limiting nutrients: nitrogen, which nourishes photosynthesis; and silicon, which nourishes cell division. The spring bloom terminates abruptly when these nutrients are depleted in the mixed layer, leaving summer oligotrophy. As the mixed layer continues to thin during spring, unconsumed nutrients are subducted into the seasonal thermocline producing well-defined nutriclines for nitrate, ammonium and silicate.

VEW 3.3 has a sophisticated function for managing nutrient uptake in phytoplankton<sup>7</sup>. This is needed in an individual-based model like LERM. The procedure manages nutrient (or prey) uptake in two stages. First the demand for nutrients is computed for each computer agent, taking account of the number of plankters in its sub-population. The total demand in each one-metre-thick layer of the virtual mesocosm is computed by summing over all the agents in that layer. If the supply of nutrient in the layer is sufficient to satisfy the demand, the uptake proceeds in full for each diatom. If not the demand is scaled back to avoid creating a negative concentration in the water. This procedure is particularly important when nutrient depletion terminates the spring bloom. It is also important for managing uptake of the nutrients during the period of summer oligotrophy, when migrating zooplankton generate a supply so weak that it is immediately taken up by phytoplankton. It is not necessary to write equations in LERM for this management of nutrient uptake; it is performed automatically by VEW 3.3.

## Primary production above the nutriclines

We know from analysis of WB virtual ecosystems, that primary production (i.e. diatom cell division) continues in the oligotrophic layer above the nutriclines (Woods 2005). This production is nourished by nutrients injected by zooplankton performing diel migration. The nutrients are injected in two ways: (1) directly by excretion from living zooplankton, and (2) indirectly by microbial action on faecal pellets released above the nutricline, or on the corpses of zooplankton that die there. In WB the zooplankton were herbivores; in LERM they are herbivores, carnivores and top predators. This process of oligotrophic remineralization is important for realistic simulation of seasonal change in the phytoplankton population. (It is therefore one of the design criteria for zooplankton and top predators).

## Motility

LERM diatoms sink at a constant speed (1m/s) as in the WB model. This applies to both living and dead diatoms.

---

<sup>7</sup> A similar procedure is used to manage depletion due to grazing and predation by zooplankton and top predators. This will be described in later Parts.

## Overview for Phytoplankton

Fig. 1.1 Biological state variables (green box), biological processes (inputs orange, outputs blue), ambient environment (yellow).

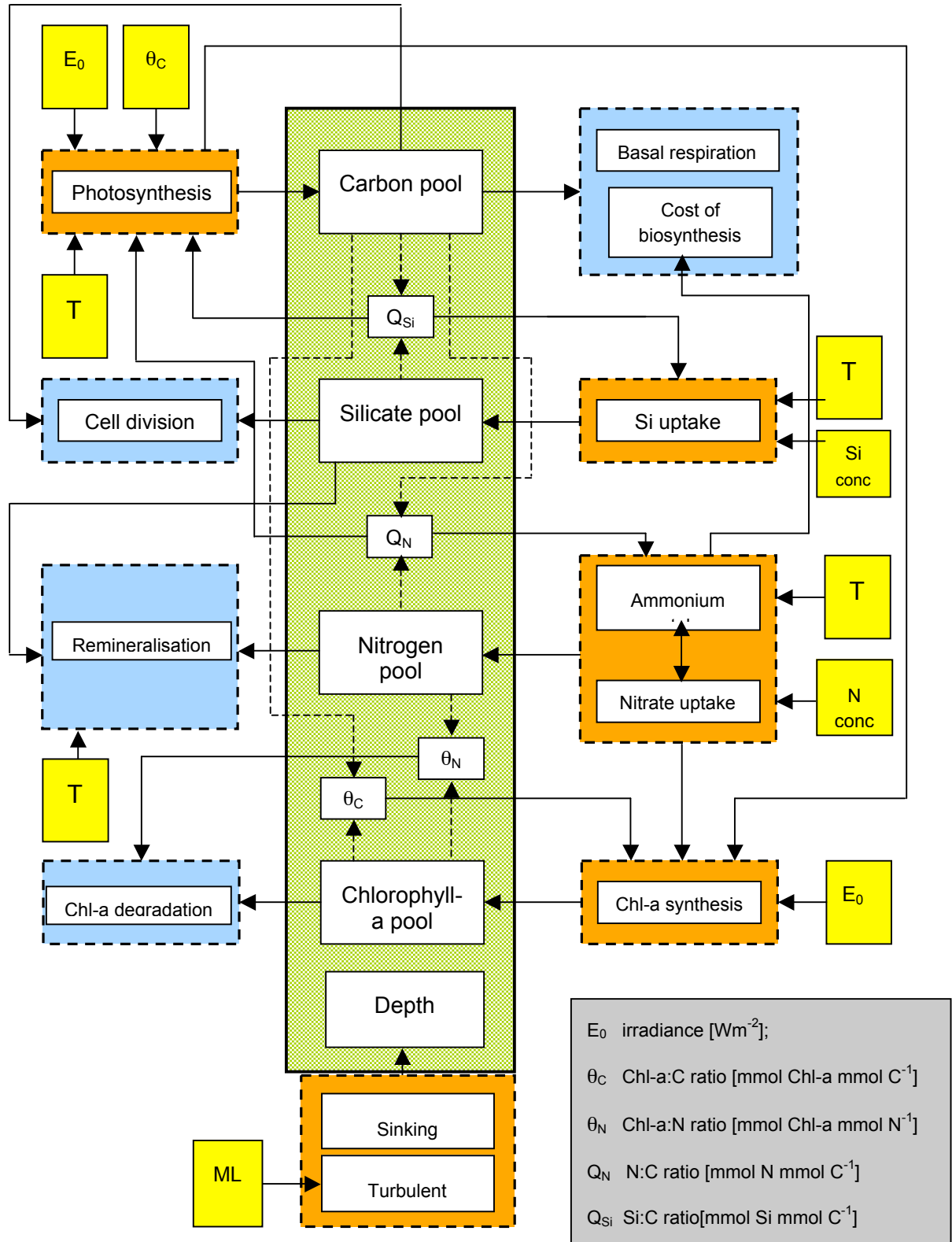

## State variables

Ammonium <sub>pool</sub>	= Ammonium pool [mmol N]	}	Nitrogen <sub>pool</sub>
Nitrate <sub>pool</sub>	= Nitrate pool [mmol N]		
Chlorophyll <sub>pool</sub>	= Chlorophyll a pool [mg Chl-a]		
Carbon <sub>pool</sub>	= Carbon pool [mmol C]		
Silicate <sub>pool</sub>	= Silicon pool [mmol Si]		

## Parameters

Table 1.1 diatom parameter list.

name in edit species	name in equation editor	Description	Value	Units	Source
A_E,	$A_E, A_E$	slope of linear region of Arrhenius plot	$-10^{-4}$	°K	Geider et al.,1997
Alpha_Chl	$\alpha^{Chl}$	initial slope of photosynthetic light curve	$7.9 \times 10^{-7}$	$\text{mmolC m}^2 (\mu\text{E mg Chl a})^{-1}$	Geider et al.,1998
C_minS	$C_{smin}$	minimum C content for Si uptake	$1.58 \times 10^{-8}$	Mmol C	Brzezinski, 1985
C_rep	$C_{rep}$	C content threshold for cell division	$1.76 \times 10^{-8}$	mmol C	Strathmann, 1967
C_starve	$C_{starve}$	carbon content threshold for starvation	$8.5 \times 10^{-9}$	nmol C	Assumed
K_AR	$K_{AR}$	half saturation constant for uptake of nitrate and ammonium	1	$\text{nmol N m}^{-3}$	Geider et al.,1998
K_S	$k_S$	half-saturation constant for Si uptake	1	$\text{nmol Si m}^{-3}$	Tett & Droop, 1988
	n	decline of $V_{max}^C$ with $Q_N$ increase	0.05	dimensionless	Partridge, pers c.
Ndis	$N_{dissolution}$	N specific dissolution rate of N	0.0042	$\text{mmolN (mmolN h)}^{-1}$	Heath et al, 1997
P_ref_c	$P_{ref}^C$	maximum value $P_{photC}$ at temp $T_{ref}$	0.14	$\text{nmol C (mmol C)}^{-1} \text{h}^{-1}$	Geider et al.,1998
Q_Nmax	$Q_{N,max}$	maximum nitrogen to carbon ratio	0.17	$\text{nmol N (mmol C)}^{-1}$	Geider et al.,1998
Q_Nmin	$Q_{N,min}$	minimum nitrogen to carbon ratio	0.034	$\text{nmol N (mmol C)}^{-1}$	Geider et al.,1998
Q_remN	$Q_{RemN}$	N dissolution factor increase with T	2.95	dimensionless	Heath et al, 1997
Q_remS	$Q_{RemS}$	Si dissolution factor increases with T (K)	2.27	dimensionless	Kamatani, 1982
Q_S_min	$Q_{S,min}$	minimum silicon:carbon quota	0.04	$\text{nmol Si (mmol C)}^{-1}$	Brzezinski, 1985
Q_S_max	$Q_{S,max}$	maximum silicon:carbon quota	0.15	$\text{nmol Si (mmol C)}^{-1}$	Brzezinski, 1985
R_ChI	$R_{ChI}$	ChI specific rate of ChI degradation	$2 \times 10^{-3}$	$\text{mgChI (mg ChI)}^{-1} \text{h}^{-1}$	Geider et al,1996
R_maintenance	$R_{maint.}^C$	C specific respiration maintenance rate	$2 \times 10^{-3}$	$\text{nmol C (mmol C)}^{-1} \text{h}^{-1}$	Geider et al., 1996
R_N	$R_N$	N specific rate of N remineralisation	$2 \times 10^{-3}$	$\text{nmol N (mmol N)}^{-1} \text{h}^{-1}$	Geider <i>et al.</i> , 1996
S_dis	$S_{dissolution}$	Si specific dissolution rate of biogenic Si	$8.3 \times 10^{-4}$	$\text{nmol Si (mmolSi h)}^{-1}$	Hurd&Birdwhistell, 1983

LERM – Technical documentation

S <sub>rep</sub>	S <sub>rep</sub>	Si content threshold for cell division	2.1×10 <sup>-9</sup>	nmol Si	from Cr <sub>ep</sub> & Table 3 Brzezinski, 1985
T <sub>ref</sub>	T <sub>ref</sub>	Reference temperature	293	°K	Geider <i>et al.</i> , 1997
T <sub>refN</sub>	T <sub>Nref</sub>	Reference T for Silicate remineralization	283	°K	Heath <i>et al.</i> , 1997
T <sub>refS</sub>	T <sub>Sref</sub>	Reference T for Silicate dissolution	278	°K	Hurd&Birdwhistell, 1983
Theta_max_N	θ <sub>max</sub> <sup>N</sup>	maximum Chl a:N ratio	4.2	mg Chl a(mmol N) <sup>-1</sup>	Geider <i>et al.</i> , 1998
V <sub>ref_c</sub>	VC <sub>ref</sub>	Value of V <sub>maxC</sub> at temperature T <sub>ref</sub>	0.026	nmol N (mmol C) <sup>-1</sup> h <sup>-1</sup>	Geider <i>et al.</i> , 1998
V <sub>S_ref</sub>	V <sub>ref</sub> <sup>S</sup>	value of V <sub>max</sub> <sup>S</sup> at temperature T <sub>ref</sub>	0.03	mmol Si (mmol Si) <sup>-1</sup> h <sup>-1</sup>	Paasche, 1973
Z <sub>sink</sub>	v <sub>s</sub>	sinking velocity	0.04	m h <sup>-1</sup>	Woods & Barkmann, 1993
Zeta	ζ	cost of biosynthesis	2.3	mmol C (mmol N) <sup>-1</sup>	Geider <i>et al.</i> , 1997



## Chemical pools in a diatom

Four internal pools, one for each nutrient (nitrogen and silicon), one for carbon and one for chlorophyll-a define the physiological state of each diatom. At any time, a diatom exists in one of two states: dead or alive.

<i>a</i>	Min	Max	Units	Functions	Reference
C	$8.5 \times 10^{-9}$	$2.6 \times 10^{-8}$	mmol C	State variable	Strathmann, 1967 Gilpin <i>et al.</i> , 2004
N	$7.8 \times 10^{-10}$	$1.44 \times 10^{-9}$	mmol N	State variable	Geider <i>et al.</i> 1998
Si	$1.0 \times 10^{-9}$	$2.1 \times 10^{-9}$	mmol Si	State variable	Brzezinski, 1985
Chl-a <sup>8</sup>	0	$3.3 \times 10^{-9}$	mg Chl-a	State variable	Geider <i>et al.</i> , 1998
<i>b</i>	Min	Max	Units	Physiological process	Reference
N:C	0.03	0.17	mmol N : mmol C	Max photosynthesis Max N uptake	Geider <i>et al.</i> , 1998
Si:C	0.04	0.15	mmolSi : mmolC	Max photosynthesis Max Si uptake	Brzezinski, 1985
Chl-a:C	0	0.39	mg Chl-a: mmol C	Photosynthesis Chl-a synthesis	Geider <i>et al.</i> , 1998
Chl-a:N	0	4.2	mg Chl-a: mmol N	Chl-a synthesis Chl-a degradation	Geider <i>et al.</i> , 1998

Table 1.2 (a) stoichiometric composition of a diatom; (b) ratio of chemical pools and pertaining physiological processes.

<sup>8</sup> LERM measures Chlorophyll-a in mg. VEW requires this unit for Ch-I pools for the calculation of bio-optical feedback. The conversion factor molar mass of Chlorophyll-a ( $C_{55}H_{72}MgN_4O_5$ ) is  $893.509 \text{ g mol}^{-1}$ . Then  $1 \text{ mmol} = 0.894 \text{ gr Chl-a}$

## Biological rules

<i>Process</i>	<i>Characteristics</i>	<i>References</i>
1. Effect of temperature		Geider <i>et al.</i> , (1998)
2. Photosynthesis	Geider photoadaptive model	Geider <i>et al.</i> , (1998)
3. Chlorophyll synthesis	Geider photoadaptive model	Geider <i>et al.</i> , (1998)
4. Respiration	Basal metabolic cost	Geider <i>et al.</i> , (1998)
	Cost of biosynthesis	Geider <i>et al.</i> , (1998)
5. Cell division	Carbon threshold for cell division	Woods&Barkmann (1994)
	Silicon threshold for cell division	Brzezinski, (1985)
6. Nutrients uptake		
Ammonium, Nitrogen	Droop dynamics	Tett & Droop (1998)
	Internal quotas to regulate uptake	Geider <i>et al.</i> (1998)
Silicon uptake	Internal quotas to regulate uptake	Tett & Droop (1998)
	Paasche (1973)	
7. Update pools		
8. Mortality	Calculated for 18 days starvation	Berges&Falkowski (1998) (Veldhuis <i>et al.</i> (2001) Geider <i>et al.</i> , (1998)
9. Motility	Constant sinking speed	Woods&Barkmann (1994)
10. Remineralization	Nitrogen excreted	Heath et al. (1997), Kamatani (1982), Geider et al. (1996), Hurd & Birdwhistell (1983)

## 1. Effect of temperature

Several of the biological functions in LERM exhibit sensitivity to ambient temperature, defined as the temperature of the seawater at the precise location of the plankter. This is expressed by multiplying the phenotypic rule by a temperature sensitivity factor  $T_{function}$ .

Rule 1.1 defines the conversion between from °C to °K

**Rule 1.1**

$$T_K = (Temp + 273)$$

**Where**

$T_K$  = ambient temperature [°K]

Temp = ambient temperature [°C]

Rule 1.2 defines effect of temperature on a biological process, Arrhenius plot:

**Rule 1.2**

$$T_{function} = e^{(A_E (1/T_K) - (1/T_{ref}))}$$

**Where**

$T_{function}$  = temperature function [dimensionless]

$T_{ref}$  = 293 [°K]

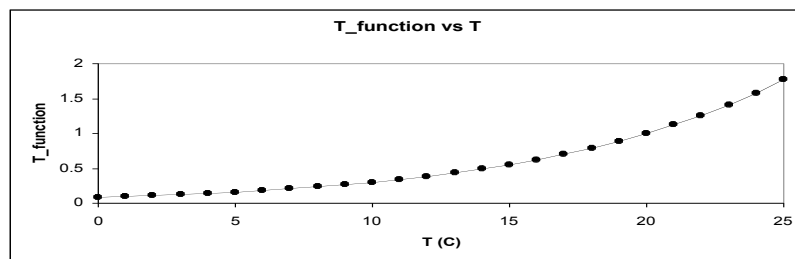

Fig. 1.3 Temperature function expressing the effect of temperature on the biological processes of diatoms (derived from Geider et al , 1998)

---

### Parameters values in the literature

$A_E$  = -  $10^4$  [°K] From Geider et (1998)

$T_{ref}$  = 293 [°K] From Geider et (1998)

## 2. Photosynthesis

LERM uses molar units for chemicals. Conversion:

$$1 \text{ mole of N} = 14 \text{ gN} \quad 1 \text{ mole of C} = 12 \text{ gC}$$

Rule 1.3 defines the nitrogen to carbo ratio:

### Rule 1.3

$$Q_N = \frac{\text{Ammonium}_{\text{pool}} + \text{Ammonium}_{\text{ingested}} + \text{Nitrate}_{\text{pool}} + \text{Nitrate}_{\text{ingested}}}{\text{Carbon}_{\text{pool}}}$$

Where:

$Q_N$	= N:C ratio [mmolN mmolC <sup>-1</sup> ]
$\text{Ammonium}_{\text{pool}}$	= Nitrogen pool [mmolN]
$\text{Ammonium}_{\text{ingested}}$	= Nitrogen ingested per time step [mmolN h <sup>-1</sup> ]
* $\text{Nitrate}_{\text{pool}}$	= 0 [mmolN]
* $\text{Nitrate}_{\text{ingested}}$	= 0 [mmolN h <sup>-1</sup> ]

\* Ammonium represents the nitrogen. This rule is left from a previous definition of nitrogen.

Rule 1.3 defines the silicate to carbo ratio:

### Rule 1.4

$$Q_S = \frac{\text{Silicate}_{\text{pool}} + \text{Silicate}_{\text{ingested}}}{\text{Carbon}_{\text{pool}}}$$

Where:

$Q_S$	= Si:C ratio [mmolSi mmolC <sup>-1</sup> ]
$\text{Silicate}_{\text{pool}}$	= Silicon pool [mmolSi]
$\text{Silicate}_{\text{ingested}}$	= Silicate ingested per time step [mmolSi h <sup>-1</sup> ]

Rule 1.5 defines the maximum carbon specific rate of photopsynthesis  $P_{\text{max}_c}$

### Rule 1.5

$$P_{\text{max}_c} = \left( \text{if} (Q_N > Q_{N\text{max}}) \text{ then } (P_{\text{ref}_c} T_{\text{function}}) \text{ else if} (Q_N < Q_{N,\text{min}}) \text{ then } 0 \right. \\ \left. \text{else } (P_{\text{ref}_c} T_{\text{function}} \frac{(Q_N - Q_{N\text{min}})}{(Q_{N\text{max}} - Q_{N\text{min}})}) \right)$$

Where:

$P_{\text{max}_c}$	= maximum C specific rate of photosynthesis [mmolC mmolC <sup>-1</sup> h <sup>-1</sup> ]
$Q_{N\text{min}}$	= 0.034 [mmolN mmolC <sup>-1</sup> ] minimum N:C ratio
$Q_{N\text{max}}$	= 0.17 [mmolN mmol C <sup>-1</sup> ] maximum N:C ratio
$P_{\text{ref}_c}$	= 0.14 [mmolC mmolC <sup>-1</sup> h <sup>-1</sup> ]
$T_{\text{function}}$	= effect of temperature on metabolic rates [dimensionless]

Rule 1.6 defines the Chlorophyll-a to carbon rate:

**Rule 1.6**

$$\text{Theta}_C = \frac{\text{Chlorophyll}_{\text{pool}}}{\text{Carbon}_{\text{pool}}}$$

Where:

$\text{Theta}_C$  = Chl-a:C ratio [mg Chl-a mmolC<sup>-1</sup>]  
 $\text{Chlorophyll}_{\text{pool}}$  = Chlorophyll [mg Chl-a]  
 $\text{Carbon}_{\text{pool}}$  = Carbon<sub>pool</sub> [mmolC]

Rule 1.7 to convert irradiance from [W m<sup>-2</sup>] into [E = μmol photons m<sup>-2</sup> s<sup>-1</sup>]

**Rule 1.7 :**

$$E_0 = 4.6 \text{ Vis}_{\text{irrad}}$$

Where:

$E_0$  = incident scalar PAR (400nm-700nm) irradiance [E]  
 $\text{Vis}_{\text{irrad}}$  = ambient visible (400nm-700nm) irradiance [W m<sup>-2</sup>]

Rule 1.8 computes photosynthetic rate:

**Rule 1.8 :**

$$P_{\text{phot}_c} = (\text{if } (P_{\text{max}_c} = 0.0) \text{ or } (Q_S \leq Q_{S\text{min}}) \text{ then } 0 \\ (-3600 \text{ Alpha\_Chl Theta\_C } E_0) / P_{\text{max}_c} \\ \text{else } (P_{\text{max}_c} (1 - e^{\quad})))$$

Where:

$P_{\text{phot}_c}$  = carbon specific rate of photosynthesis at ambient T [mmolC mmolC<sup>-1</sup> h<sup>-1</sup>]  
 $\text{Alpha\_Chl}$  =  $7.9 \cdot 10^{-7}$  [(mmolC m<sup>2</sup>) (μE mgChl-a)<sup>-1</sup>] initial slope of photosynthetic light curve  
 $E_0$  = incident scalar PAR (400nm-700nm) irradiance [E]  
 $P_{\text{max}_c}$  = max. C specific rate of photosynthesis at ambient temperature [mmolC mmolC<sup>-1</sup> h<sup>-1</sup>]  
 $\text{Theta}_C$  =  $\text{Chl}_{\text{pool}} / \text{C}_{\text{pool}}$  = Chl-a:C ratio within the cell [mg Chl-a mmolC<sup>-1</sup>]

## From the literature on photosynthesis

The phenotypic rules for photosynthesis governing the process in LERM are taken from Geider *et al*, 1998:

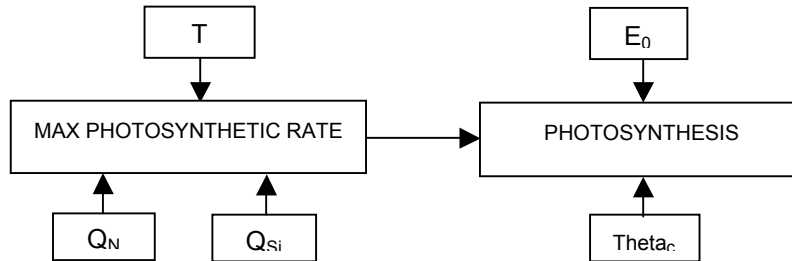

Fig. 1.4 Photosynthesis components, internal and external controlling factors.

The rate of carbon specific photosynthesis ( $P_{\text{phot}_C}$ ) is a function of the maximum photosynthetic rate, of the incident PAR irradiance ( $E_0$ ), and of the internal ratio Chl-a:C ( $\text{Theta}_C$ ).

The maximum photosynthetic rate  $P_{\text{max}}^C$  is a function of temperature  $T$ , and of the internal quotas N:C ( $Q_N$ ) and Si:C ( $Q_{\text{Si}}$ ). If Si:C drops below 0.04 [ $\text{mmolSi mmolC}^{-1}$ ] (Brzezinski, 1985) dissolved silicate becomes limiting, and diatoms in the reproductive phase stop fixing carbon.

Photosynthetic rate is sensitive to N:C internal quota when light is saturated; to Chl-a:C internal quota when light is limited, and to Si:C internal quota when ambient silicate is depleted.

At low irradiance photosynthetic rate is higher when Chl-a:C internal quota is high. At high irradiance it is controlled by the maximum rate of photosynthesis, and therefore by the N:C internal quota.

*Parameters values in the literature*

- $P_{ref\_C}$  = 0.14 [mmolC (mmolC)<sup>-1</sup>h<sup>-1</sup>] max. C specific photosynthetic rate at  $T_{ref}$   
 From Geider *et al.* (1998, eq. 10) the average value of the maximum C photosynthetic rate at  $T=293$  °K (negligible effect of temperature):  
 $P_{ref\_C} = 4 \text{ gC (gC d)}^{-1}$   
 $P_{max\_C} = P_{ref\_C} f_{T_{function}}(Q - Q_{min}) / (Q_{max} - Q_{min})$   
 $Q_n = 0.15 \text{ mmolN mmolC}^{-1}$  (N:C content)  
 $P_{max}^C = P_{ref}^C ((0.15-0.034)/(0.17-0.034)) [\text{mmolC mmolC}^{-1} \text{ h}^{-1}] =$   
 $= 0.85 P_{Cref} / 24 (\text{h d}^{-1}) =$   
 $= 0.85 / 24 (\text{h d}^{-1}) 4 \text{ gC (gC d)}^{-1} = 0.14 \text{ mmol C (mmol C h)}^{-1}$
- Alpha\_ChI = initial slope of photosynthetic light curve [mmolC m<sup>2</sup> (μE mg ChI-a)<sup>-1</sup>] =  $7.9 \cdot 10^{-7} \text{ mmolC m}^2 (\mu\text{E mg ChI-a})^{-1}$   
 Geider *et al.* (1997, Tab. 2) provided an averaged value for diatoms  
 $\text{Alpha\_ChI} = 0.95 \cdot 10^{-5} \text{ gC m}^2 (\text{gChI } \mu\text{mol photons})^{-1}$   
 1 mol of photons = 1 Einstein (E)  
 $\text{Alpha\_ChI} = 0.95 \cdot 10^{-8} \text{ gC m}^2 (\text{mgChI } \mu\text{E})^{-1} =$   
 $= 0.95 \cdot 10^{-8} \text{ gC m}^2 (\text{mg ChI mE})^{-1} / [12 \cdot 10^{-3} \text{ gC mmolC}^{-1}] =$   
 $= 7.9 \cdot 10^{-7} \text{ mmolC m}^2 (\mu\text{E mg ChI-a})^{-1}$
- $Q_{N,min}$  = minimum N:C = 0.04 gN (gC)<sup>-1</sup>  
 from (Geider *et al.*, 1998, table 3) for *Pavlova lutheri*, *Skeletonema costatum*, *Thalassiosira pseudonana*, *Isochrysis galbana*
- $Q_{N,max}$  = maximum N:C = 0.20 gN (gC)<sup>-1</sup>  
 for *Pavlova lutheri*, *Skeletonema costatum*, *Thalassiosira pseudonana*, *Isochrysis galbana*
- $T_{function}$  = defines the effect of temperature on metabolic rates (dimensionless)

### 3. Chlorophyll synthesis

LERM uses molar units for chemicals and for solar radiation. Conversion:

$$\begin{aligned} 1 \text{ mole of N} &= 14 \text{ gN} \\ 1 \text{ mole of photons} &= 1 \text{ Einstein [E]} \\ 1 \text{ W} &= 4.6 \mu \text{ E s}^{-1} \end{aligned}$$

Rule 1.9 defines the internal ratio of Chl to N:

**Rule 1.9**

$$\text{Theta}_N = \frac{\text{Chlorophyll}_{\text{pool}}}{\text{Ammonium}_{\text{pool}} + \text{Ammonium}_{\text{ingested}} + \text{Nitrate}_{\text{pool}} + \text{Nitrate}_{\text{ingested}}}$$

**Where:**

$\text{Theta}_N$	= Chl-a:N ratio [mgChl mmolN <sup>-1</sup> ]
$\text{Ammonium}_{\text{pool}}$	= Nitrogen pool [mmolN]
$\text{Ammonium}_{\text{ingested}}$	= Nitrogen ingested per time step [mmolN h <sup>-1</sup> ]
* $\text{Nitrate}_{\text{pool}}$	= 0 [mmolN]
* $\text{Nitrate}_{\text{ingested}}$	= 0 [mmolN h <sup>-1</sup> ]

\* Ammonium represents nitrogen.

Rule 1.10 defines the amount of chlorophyll produced per time-step as a function of the level of the ambient irradiance:

**Rule 1.10**

$$\text{Rho}_{\text{Chl}} = \left( \text{if } (E_0 > 0) \text{ and } (\text{Theta}_{\text{c}} > 0) \text{ then } \left( \text{Theta}_{\text{max\_N}} \frac{P_{\text{phot\_C}}}{(3600 \text{ Alpha}_{\text{Chl}} \text{ Theta}_{\text{c}} E_0)} \right) \right. \\ \left. \text{else } 0 \right)$$

**where:**

$E_0$	= incident scalar PAR irradiance [Wm <sup>-2</sup> ]
$\text{Rho}_{\text{Chl}}$	= Chl-a synthesis regulation index [mg Chl-a mmolN <sup>-1</sup> ]
$\text{Theta}_{\text{max\_N}}$	= 4.2 [mg Chl-a mmolN <sup>-1</sup> ] maximum value for the Chl-a:N ratio
$P_{\text{phot\_C}}$	= carbon specific photosynthesis rate at ambient T [mmolC mmolC <sup>-1</sup> h <sup>-1</sup> ]
$\text{Alpha}_{\text{Chl}}$	= $7.9 \cdot 10^{-7}$ [mmolC m <sup>2</sup> (μE mg Chl-a) <sup>-1</sup> ] initial slope of photosynthetic light curve
$\text{Theta}_{\text{c}}$	= Chl a:C ratio within the cell [mg Chl-a mmolC <sup>-1</sup> ]



## From the literature on Chlorophyll synthesis

### Model for photo-adaptation

Photo-adaptation is modelled as a dynamic allocation to the cell of light-harvesting components (L) energy storage compounds (R, polysaccharides and lipids), and biosynthetic apparatus (E, enzymes for carbon fixation and new cell elaboration). From Geider *et al.* (1996):

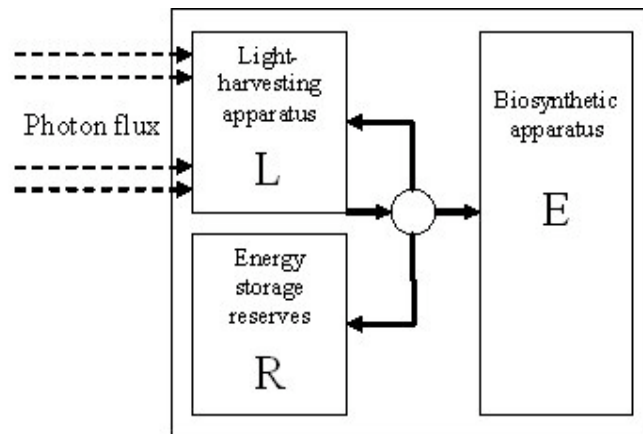

Fig. 1.2 – Photo-adaptation (adapted from Geider *et al.*, 1996)

Carbon fixation is a function of L and E. L controls light-limited photosynthesis, E controls light-saturated photosynthesis.

The rate of chlorophyll synthesis is therefore a function of: ambient irradiance, the value of the light saturation parameter and nitrogen assimilation.

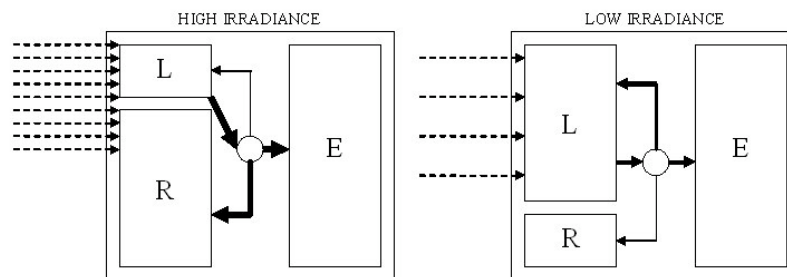

Fig. 1.3 Adapted from Geider *et al.*, 1996

### Parameters values in the literature

$\Theta_{\max\_N} = 4.2 \text{ [mg Chl-a mmolN}^{-1}\text{]}$  maximum value for the Chl-a:N ratio  
 From Geider *et al.* (1998, table 3) for the diatom *S. costatum*

$\alpha_{\text{Chl}} = 7.9 \cdot 10^{-7} \text{ mmolC m}^2 (\mu\text{E mg Chl-a})^{-1}$   
 Geider *et al.* (1997, Tab. 2) provided an averaged value for diatom

#### 4. Respiration

LERM defines the respiration rate as the carbon loss due to metabolic activities. The respiration has two components: (i) growth-related respiration ( $R_{C\_growth}$ ) and (ii) basal respiration ( $R_C$ )

Rule 1.11 defines the C specific rate of growth – related respiration:

**Rule 1.11**

$$R_{C\_growth} = \frac{(\text{Ammonium}_{\text{ingested}} + \text{Nitrate}_{\text{ingested}}) \text{ Zeta}}{\text{TimeStep Carbon}_{\text{pool}}}$$

where

- $R_{C\_growth}$  = C specific rate of growth related respiration [ $\text{mmolC} (\text{mmol C})^{-1} \text{h}^{-1}$ ]
- Zeta = cost of biosynthesis = 2.3 [ $\text{mmolC} \text{mmolC}^{-1}$ ]
- $\text{Ammonium}_{\text{ingested}} + \text{Nitrate}_{\text{ingeste}}$  = C specific rate of N uptake [ $\text{mmol N} (\text{mmol C})^{-1} \text{h}^{-1}$ ]
- TimeStep = 0.5 [h]

Rule 1.12 defines the C specific rate of respiration:

**Rule 1.11**

$$R_C = R_{\text{maintenance}} + R_{C\_growth}$$

where

- $R_C$  = total C specific rate of respiration [ $\text{mmolC} (\text{mmol C})^{-1} \text{h}^{-1}$ ]
- $R_{\text{maintenance}}$  =  $2 \cdot 10^{-3}$  [ $\text{mmolC} (\text{mmol C})^{-1} \text{h}^{-1}$ ] C specific rate of maintenance respiration
- $R_{C\_growth}$  = C specific rate of growth related respiration

---

#### From the literature on respiration

LERM follows the dynamic regulatory model of phytoplanktonic acclimation proposed by Geider *et al.* (1998). They assume that the total respiration rate has two components: cost of basal metabolism, assumed to be constant, and cost of biosynthesis, linear function of nitrogen uptake.

The respiration term is significant only at very low irradiances for diatoms with high light-saturated growth rates (Geider *et al.* 1996).

Geider *et al.* (1998) assume that the maintenance metabolic rate constants describing:

- $R_{\text{maintenance}}$  = C specific respiration maintenance rate
- $R_N$  = respiration cost of N specific rate of remineralization
- $R_{\text{Chl}}$  = Chl specific rate of Chl degradation

are function of T and have the same value: 0.05 [ $\text{mmolC} (\text{mmol C d})^{-1}$ ]

---

*Parameters values in the literature*

$$R_{\text{maintenance}} = 2 \cdot 10^{-3} \text{ [mmolC (mmol C)}^{-1}\text{h}^{-1}\text{]}$$

From Geider *et al.* (1996, 1998)

$$\text{Zeta} = 2.3 \text{ [mmolC mmolC}^{-1}\text{] cost of biosynthesis}$$
$$= 2 \text{ gC gN}^{-1} \text{ (Geider } et al. \text{ 1998, table 3)}$$

## 5. Cell division

In LERM diatoms start to uptake silicate to build their valves when the carbon pool reaches 90% of the threshold for cell division. Diatoms divide when both the carbon and silicon pool have both reached the threshold value for cell division. Silicon depletion in the water may limit diatom reproduction before nitrogen depletion.

Rule 1.13 defines for cell division is:

<b>Rule 1.13</b>	
$C_d = (\text{if } (((\text{Carbon}_{\text{pool}} + (\text{Carbon}_{\text{pool}} (\text{P}_{\text{phot\_C}} - R_C) \text{TimeStep})) \geq C_{\text{rep}}) \text{ and } ((\text{Silicate}_{\text{pool}} + \text{Silicate}_{\text{ingested}}) \geq S_{\text{rep}})) \text{ then } 2 \text{ else } 1)$	
<i>where</i>	
$C_d$	= flag for diatom maturity [dimensionless]
$\text{Carbon}_{\text{pool}}$	= carbon pool [mmol C]
$C_{\text{rep}}$	= carbon content threshold for cell division = $1.7610^{-8}$ [mmol C]
$\text{P}_{\text{phot\_C}}$	= carbon specific photosynthetic rate [mmolC mmolC <sup>-1</sup> h <sup>-1</sup> ]
$R_C$	= carbon specific respiration rate [mmolC mmolC <sup>-1</sup> h <sup>-1</sup> ]
$\text{Silicate}_{\text{ingested}}$	= silicon ingested [mmol Si h <sup>-1</sup> ]
$\text{Silicate}_{\text{pool}}$	= silicon pool [mmol Si]
$S_{\text{rep}}$	= silicon content threshold for cell division = $2.1 \cdot 10^{-9}$ [mmol Si]
$\text{TimeStep}$	= 0.5 [h]

Rule 1.14 defines the creation of a new diatom is created when  $c_d = 2$

<b>Rule 1.14</b>	
$\text{if } (C_d = 2), \text{ then divide}(2)$	
<i>where</i>	
$C_d$	= flag for diatom maturity [dimensionless]

After cell division the daughter and parent cell have each the same amount of carbon, nitrogen, silicon and chlorophyll (half the value in the parent cell immediately before division).

## Lagrangian Ensemble agents

LERM is an individual-based model. The LERM phenotypic rules apply to a single diatom.

However they are coded in a way that facilitates Lagrangian Ensemble integration. In this box we describe what that implies for reproduction, merely as background information.

The LE metamodel uses a set of computer agents to represent the diatom population.

Each diatom behaves like a single plankter obeying the phenotypic rules.

It also carries information about a sub-population of identical diatoms.

All the diatoms in this sub-population reproduce at the same time.

There is no difference between the mother and daughter diatoms; they have the same masses of chemicals in their Droop pools.

So the daughter diatoms can be kept in the same sub-population – the same computer agent – as the mother diatoms.

That is the LE procedure for phytoplankton reproduction.

The LE procedure is different for zooplankton reproduction. The offspring are very much smaller than the mother; they have different metabolic rates and swimming speeds. So they cannot be grouped in the same computer agent. When zooplankton reproduce a new computer agent is created to carry the offspring.

---

### From the literature on cell division

The threshold of carbon content for cell division is derived the relation between diatom volume and carbon content in Strathmann (1967) assuming for the LERM diatoms an equivalent spherical diameter of 20  $\mu\text{m}$ .

---

#### *Parameters values in the literature*

$C_{\text{rep}}$  = carbon content threshold for cell division =  $1.76 \cdot 10^{-8}$  [mmol C]  
 relation between diatom volume  $V$  ( $\mu\text{m}^3$ ) and carbon content,  $C$  (pgC)  
 $\text{Log } C = -0.422 + 0.758 \log(V)$  from Strathmann (1967)  
 Assuming spherical diameter) of 20  $\mu\text{m}$ ,  $V$  ( $\mu\text{m}^3$ ) =  $4/3 \pi 10^3 = 4200 \mu\text{m}^3$   
 Then  $\text{Log } C = 2.32$   $C = 210 \text{ pgC } 1.75 \cdot 10^{-8} \text{ mmolC}$

$S_{\text{rep}}$  = silicon content threshold for cell division =  $2.1 \cdot 10^{-9}$  [mmol Si]  
 It is estimated from  $C_{\text{rep}} = 1.76 \cdot 10^{-8}$  using the average Si:C ratio = 0.12 according to Brzezinski (1985, table 3) then:  
 $S_{\text{rep}} = C_{\text{rep}} 0.12 = 2.1 \cdot 10^{-9} \text{ mmolSi}$

## 6. Nutrients uptake

The nutrients for LERM are nitrate, ammonium and silicate.

Nitrogen is the limiting nutrient for photosynthesis and therefore for the whole chain of biological production. The resource for that trophic flux of nitrogen is nitrate and ammonium dissolved in seawater.

LERM uses molar units for chemicals. Conversion:

$$1 \text{ mole of N} = 14 \text{ gN /molN} \quad 1 \text{ mole of C} = 12 \text{ gC /mol}$$

### Ammonium & nitrate

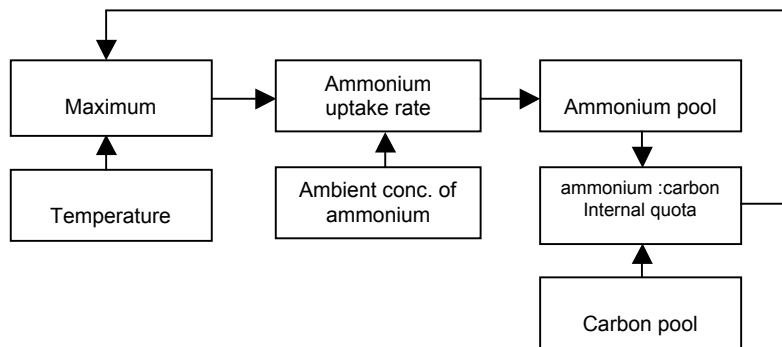

Fig. 1.5 Ammonium uptake in LERM

Rule 1.15 computes the internal ratio of nitrogen to carbon:

**Rule 1.15**

$$Q_{\text{nitrate}} = \frac{\text{Nitrate}_{\text{pool}} + \text{Nitrate}_{\text{ingested}}}{\text{Carbon}_{\text{pool}}}$$

where:

- $Q_{\text{nitrate}}$  = internal ratio N to C [mmolN mmolC<sup>-1</sup>]
- $\text{Carbon}_{\text{pool}}$  = [mmolC]
- \* $\text{Nitrate}_{\text{pool}}$  = nitrate pool [mmol N]
- $\text{Nitrate}_{\text{ingested}}$  = nitrate uptake [mmol N h<sup>-1</sup>]

\*Nitrate ingested actually enters the ammonium pool (see rules 1.26 & 1.27)

Rule 1.16 computes the internal ratio of ammonium to carbon:

**Rule 1.16**

$$Q_{\text{Ammonium}} = \frac{\text{Ammonium}_{\text{pool}} + \text{Ammonium}_{\text{ingested}}}{\text{Carbon}_{\text{pool}}}$$

where:

- $Q_{\text{Ammonium}}$  = internal ratio N to C [mmolN mmolC<sup>-1</sup>]
- $\text{Ammonium}_{\text{ingested}}$  = nitrogen uptake [mmol N h<sup>-1</sup>]
- $\text{Ammonium}_{\text{pool}}$  = nitrogen pool [mmol N]
- $\text{Carbon}_{\text{pool}}$  = [mmolC]

Rule 1.17 computes the inhibition for nitrate uptake of ammonium in the presence of ammonium:

**Rule 1.17**

$$\omega = \frac{K_{AR}}{K_{AR} + \text{Ammonium}_{\text{conc}}} \frac{K_{AR} + \text{Nitrate}_{\text{conc}}}{K_{AR} + \text{Ammonium}_{\text{conc}} + \text{Nitrate}_{\text{conc}}}$$

*where:*

- $\omega$  = ranges from 0 to 1 [dimensionless]  
inhibition factor for nitrate uptake of ammonium
- $\text{Ammonium}_{\text{conc}}$  = ammonium ambient concentration [mmol N m<sup>-3</sup>]
- $\text{Nitrate}_{\text{conc}}$  = Nitrate ambient concentration [mmol N m<sup>-3</sup>]
- $K_{AR}$  = half-saturation constant for nitrogen uptake [mmol N m<sup>-3</sup>]

Rule 1.18 maximum carbon specific uptake of nitrate and ammonium:

**Rule 1.18**

$$V_{\text{max}_c} = (\text{if } ((\text{Ammonium}_{\text{pool}} + \text{Nitrate}_{\text{pool}}) < 1000) \text{ then if } ((Q_{\text{nitrate}} + Q_{\text{ammonium}}) < Q_{N\text{min}}) \text{ Then } (V_{\text{ref}_C} T_{\text{function}}) \text{ else if } ((Q_{\text{nitrate}} + Q_{\text{ammonium}}) > Q_{N\text{max}}) \text{ then } 0.0 \text{ else } \{V_{\text{ref}_C} T_{\text{function}} [(Q_{N\text{ma}} - (Q_{\text{ammonium}} + Q_{\text{nitrate}})) / (Q_{N\text{max}} - Q_{N\text{min}})]^{0.05}\} \text{ else } 0.0)$$

*where:*

- $V_{\text{max}_C}$  = max C specific uptake of ammonium and nitrate [mmolN mmolC<sup>-1</sup> h<sup>-1</sup>]
- $\text{Ammonium}_{\text{conc}}$  = ammonium ambient concentration [mmol N m<sup>-3</sup>]
- $K_{AR}$  = half-saturation constant for nitrogen uptake [mmol N m<sup>-3</sup>]
- $\text{Nitrate}_{\text{conc}}$  = Nitrate ambient concentration [mmol N m<sup>-3</sup>]
- $Q_{\text{ammonium}}$  = internal ratio N to C [mmolN mmolC<sup>-1</sup>]
- $Q_{\text{nitrate}}$  = internal ratio N to C [mmolN mmolC<sup>-1</sup>]
- $T_{\text{function}}$  = [dimensionless] effect of temperature on metabolic rates
- $T_{\text{ref}}$  = 293 °K
- $V_{\text{ref}_C}$  = 0.01 [mmolN mmolC<sup>-1</sup> h<sup>-1</sup>] max nitrogen uptake at  $T_{\text{ref}}$

Rule 1.19 uses the Michaelis-Menten equation to compute the uptake of dissolved ammonium:

**Rule 1.19**

$$V_{C\_ammonium} = V_{max\_C} \frac{Ammonium_{conc}}{K\_AR + Ammonium_{conc}}$$

*where:*

- $V_{C\_ammonium}$  = carbon specific rate of ammonium uptake [mmolN mmolC<sup>-1</sup> h<sup>-1</sup>]
- $V_{max\_C}$  = maximum rate of nitrogen uptake, [mmolN (mmolC h<sup>-1</sup>)<sup>-1</sup>]
- $Ammonium_{conc}$  = ammonium ambient concentration [mmol N m<sup>-3</sup>]
- $K\_AR$  = half-saturation constant for the nitrogen uptake [mmol N m<sup>-3</sup>]

Rule 1.20 uses the Michaelis-Menten equation to compute the uptake of dissolved nitrate:

**Rule 1.20**

$$V_{C\_nitrate} = V_{max\_C} \omega \frac{Nitrate_{conc}}{K\_AR + Nitrate_{conc}}$$

*where:s*

- $\omega$  = ranges from 0 to 1 [dimensionless]  
inhibition factor for nitrate uptake of ammonium
- $V_{C\_nitrate}$  = carbon specific rate of nitrate uptake [mmol N (mmol C)<sup>-1</sup> h<sup>-1</sup>]
- $V_{max\_C}$  = maximum rate of nitrogen uptake, [mmol N (mmolC h<sup>-1</sup>)<sup>-1</sup>]
- $Nitrate_{conc}$  = nitrate ambient concentration [mmol N m<sup>-3</sup>]
- $K\_AR$  = half-saturation constant for the nitrogen uptake [mmol N m<sup>-3</sup>]

**Silicate.** A diatoms uses silicon to build their shell. It takes up silicate from the seawater when the diatom’s carbon pool is sufficiently full for cell division. The diatoms cannot reproduce if the dissolved silicate concentration is too low. So silicate is a limited nutrient for primary production.

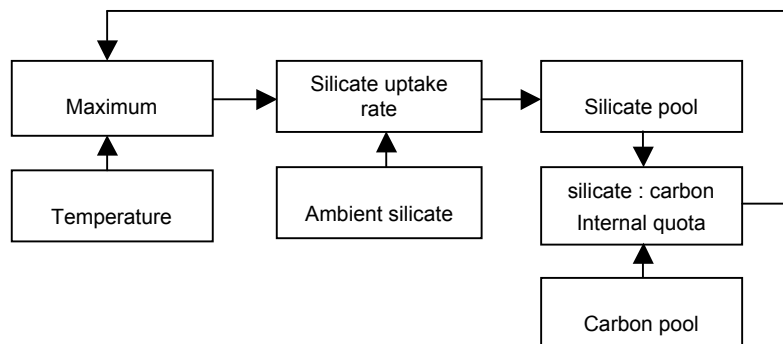

Fig 1.5 Silicate uptake



Rule 1.21 maximum silicon specific rate of silicate uptake:

**Rule 1.21**

$$V_{S\_max} = (\text{if}(\text{Carbon}_{\text{pool}} \geq C_{\text{minS}}) \text{ then } (\text{if} (Q_S \leq Q_{S\text{min}}) \text{ then } (V_{S\text{ref}} T_{\text{function}}) \text{ else } (\text{if} (Q_S \geq Q_{S\text{max}}) \text{ then } 0 \text{ else } \{V_{S\_ref} T_{\text{function}} [(Q_{S\text{max}} - Q_S) / (Q_{S\text{max}} - Q_{S\text{min}})]^{0.05}\} \text{ else } 0.0))$$

*where:*

- $V_{S\_max}$  = [mmolSi mmolSi<sup>-1</sup> h<sup>-1</sup>]
- $\text{Carbon}_{\text{pool}}$  = [mmol C]
- $C_{\text{minS}}$  = 1.58 10<sup>-8</sup> minimum carbon content for silicate uptake [mmol C]
- $Q_S$  = internal ratio Si to C [mmolSi mmolC<sup>-1</sup>]
- $Q_{S\text{min}}$  = 0.04 minimum ratio Si to C [mmolSi mmolC<sup>-1</sup>]
- $Q_{S\text{max}}$  = 0.15 maximum ratio Si to C [mmolSi mmolC<sup>-1</sup>]
- $T_{\text{function}}$  = [dimensionless] effect of temperature on metabolic rates
- $T_{\text{ref}}$  = 293 °K
- $V_{S\_ref}$  = 0.03 [mmolSi mmolSi<sup>-1</sup> h<sup>-1</sup>] value of  $V_{S\_max}$  max at  $T_{\text{ref}}$

Rule 1.22 uses the Michaelis-Menten equation to compute the uptake of dissolved silicate:

**Rule 1.22**

$$V_{S\_S} = V_{S\_max} \frac{\text{Silicate}_{\text{conc}}}{K_S + \text{Silicate}_{\text{conc}}}$$

*where:*

- $V_{S\_S}$  = carbon specific rate of silicate uptake [mmol Si (mmol Si)<sup>-1</sup> h<sup>-1</sup>]
- $K_S$  = half-saturation constant for the silicate uptake [mmol Si m<sup>-3</sup>]
- $\text{Silicate}_{\text{conc}}$  = silicate ambient concentration [mmol Si m<sup>-3</sup>]
- $V_{S\_max}$  = maximum rate of silicate uptake, [mmol Si (mmolSi h)<sup>-1</sup>]

Rule 1.23 computes ammonium uptake from water:

**Rule 1.23**

$$\text{uptake} ((\text{Carbon}_{\text{pool}} V_{C\_ammonium} \text{TimeStep}), \text{Ammonium}_{\text{conc}})$$

*where:*

- $\text{uptake}$  = VEW function (see VEW 3.3 Handbook)
- $\text{Ammonium}_{\text{conc}}$  = ambient ammonium concentration [mmol N m<sup>-3</sup>]
- $\text{Carbon}_{\text{pool}}$  = carbon pool [mmol C]
- $\text{TimeStep}$  = timestep = 0.5 h [h]
- $V_{C\_ammonium}$  = C specific rate of ammonium uptake [mmol N (mmol C)<sup>-1</sup> h<sup>-1</sup>]

Rule 1.24 computes nitrate uptake from water:

<b>Rule 1.24</b>	
	$\text{uptake}((\text{Carbon}_{\text{pool}} V_{\text{C\_nitrate}} \text{TimeStep}), \text{Nitrate}_{\text{conc}})$
<i>where:</i>	
uptake	= VEW function (see VEW 3.3 Handbook)
Carbon <sub>pool</sub>	= carbon pool [mmol C]
Nitrate <sub>conc</sub>	= ambient nitrate concentration [mmol N m <sup>-3</sup> ]
TimeStep	= timestep = 0.5 h [h]
V <sub>C_nitrate</sub>	= carbon specific rate of nitrate uptake [mmol N (mmol C) <sup>-1</sup> h <sup>-1</sup> ]

Rule 1.25 computes silicate uptake from water:

<b>Rule 1.25</b>	
	$\text{uptake}((\text{Silicate}_{\text{pool}} V_{\text{S\_S}} \text{TimeStep}), \text{Silicate}_{\text{conc}})$
<i>where:</i>	
uptake	= VEW function (see VEW 3.3 Handbook)
Silicate <sub>conc</sub>	= ambient silicate concentration [mmol Si m <sup>-3</sup> ]
Silicate <sub>pool</sub>	= silicate pool [mmol C]
TimeStep	= 0.5 [h] timestep
V <sub>S_S</sub>	= silicate specific rate of silicate uptake [mmol Si (mmol Si) <sup>-1</sup> h <sup>-1</sup> ]

## From the literature on nutrients uptake

### Michaelis-Menten equation

$V_{C,N}^C$  - The uptake of a nutrient to the pool is modelled using the traditional saturation kinetics model Michaelis-Menten equation (Droop, 1973).

$$V_{C,N} = V_{C,max} \frac{N}{K_{AR} + N}$$

where:

$V_{C,N}$  = carbon specific rate of nutrient uptake [ $\text{mmol N (mmol C)}^{-1} \text{h}^{-1}$ ]

$V_{C,Nmax}$  = maximum rate of nutrient uptake, [ $\text{mmol N (mmol C h)}^{-1}$ ]

$N$  = nutrient  $N$  ambient concentration [ $\text{mmol N m}^{-3}$ ]

$K_{AR}$  = half-saturation constant for the nutrient uptake [ $\text{mmol N m}^{-3}$ ]

It is based on three experimentally verified postulates:

- uptake depends on the external substrate concentration
- growth depends on the internal substrate concentration
- in steady state specific rate of uptake (in the absence of significant excretion) is the product of the specific growth rate and internal substrate concentration.

### Maximum uptake rate of nitrogen - $V_{CN,max}$

The maximum uptake rate of nitrogen -  $V_{C,Nmax}$  depends on the temperature and on the internal quota of nitrogen to carbon (Geider et al. 1998). This modulates the potential uptake to its stoichiometric composition.

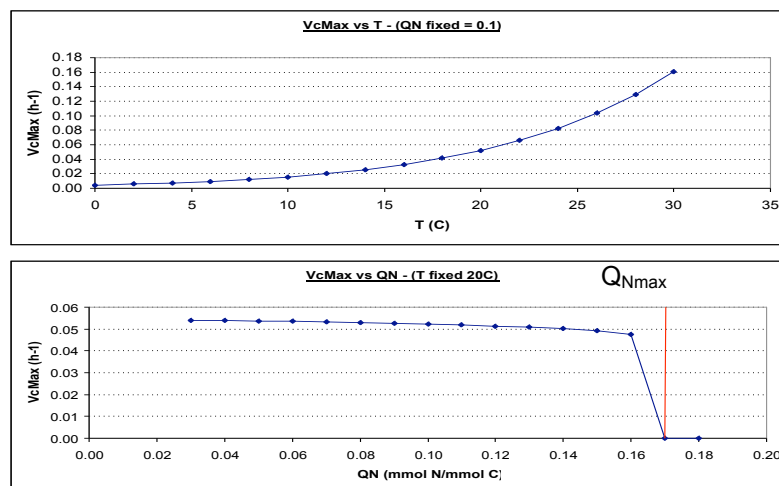

Fig. 1.6 – Maximum uptake rate of N against: a) temperature, and b) the N:C internal ratio

Experimental results indicate that ammonia is uptaken preferentially over nitrate for nitrogen concentrations ranging from nmolar to  $\mu$ molar (Harrison et al., 1996, Flynn et al., 1997). Low level of ammonia inhibits significantly nitrate uptake (Wheeler and Kokkinakis, 1990; Harrison et al., 1996).

## From the literature on silicon uptake

Brzezinski (1985) reports that diatoms start the uptake of silicate, when approaching their reproductive phase (i.e. when  $C_{pool}$  exceeds 90% of the carbon threshold for cell division  $C_{Smin}$ ).

Silicate uptake rate is modelled in the same way as ammonia; the only difference is that the Michaelis-Menten equation is silicon specific rather than carbon specific:

$$V_{S\ Si} = V_{S\ max} \frac{Si}{K_{Si} + Si}$$

where:

$V_{S\ S}$  = silicon specific rate of silicon uptake [ $mmol\ Si\ (mmol\ Si)^{-1}\ h^{-1}$ ]

$V_{S\ Smax}$  = maximum rate of silicon uptake [ $mmol\ Si\ (mmol\ Si)^{-1}\ h^{-1}$ ]

$k_S$  = half-saturation constant for silicate uptake [ $1\ mmol\ Si$ ]

$Si$  = Silicate ambient concentration [ $mmol\ Si\ m^{-3}$ ]

The maximum silicon uptake  $V_{S\ si}$  is dependent on Si:C ratio,  $Q_S$ . Brzezinski (1985) observed that Si:C ratios varied between 0.04-0.43, with the vast majority of species (27 in total) having ratios between 0.04-0.15. Mean reported:  $0.13 \pm 0.04$  (95% confidence).

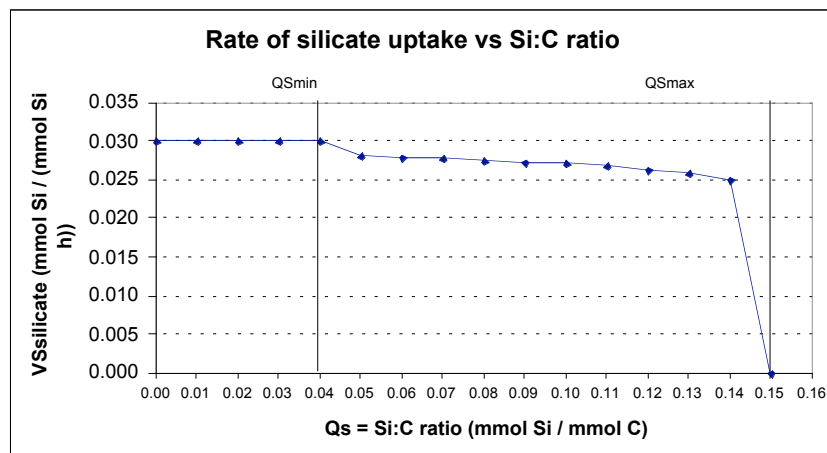

Fig.1.7– Maximum rate of Si uptake as a function of Si:C internal ratio

**Parameters values in the literature**

- $C_{smin}$  =  $1.58 \times 10^{-8}$  [mmol C] minimum C content for silicon uptake (Brzezinski, 1985).
- $C_{rep}$  =  $1.76 \times 10^{-8}$  mmolC  
 The relation between diatom volume  $V$  ( $\mu\text{m}^3$ ) and C content, C (pgC) according to Strathmann (1967) is:  $\text{Log } C = -0.422 + 0.758 \log (V)$   
 Assuming a equivalent spherical diameter of  $20 \mu\text{m}$ ,  $V = 4200 \mu\text{m}^3$   
 Then  $\text{Log } C = 2.32$   $C = 210 \text{ pgC}$   $1.75 \cdot 10^{-8}$  mmolC
- $K_S$  = half-saturation constant for the silicon uptake = 1 [mmol Si  $\text{m}^{-3}$ ]  
 From Tett and Droop (1998, pag 205 table 4)
- $n$  = 0.05 [dimensionless] rate of  $V_{C \text{ max}}$  decline with increasing  $Q_N$   
 Personal communication L. Partridge and R. Geider
- $Q_{N,min}$  = minimum N:C =  $0.04 \text{ gN (gC)}^{-1}$   
 from (Geider *et al*, 1998, table 3) for *Pavlova lutheri*, *Skeletonema costatum*, *Thalassiosira pseudonana*, *Isochrysis galbana*
- $Q_{N,max}$  = maximum N:C =  $0.20 \text{ gN (gC)}^{-1}$   
 from (Geider *et al*, 1998, table 3) as above
- $Q_{S,min}$  =  $0.04 \text{ [mmol Si (mmol C)}^{-1}]$  minimum Si:C Brzezinski (1985) observed that Si:C ratio varied between 0.04 and 0.43, with the vast majority of diatom species having ratios between 0.04 and 0.15.
- $Q_{S,max}$  =  $0.15 \text{ [mmol Si (mmol C)}^{-1}]$  maximum Si:C, from Brzezinski (1985)
- $T_{function}$  = defines the effect of temperature on metabolic rates [dimensionless]
- $T_{ref}$  = 293 °K personal communication of Prof. Geider
- $V_{Cmax}$  =  $0.8 \text{ gN (gC d)}^{-1}$  maximum rate of nitrogen uptake  
 from (Geider *et al*, 1998, table 3) average value for the 4 diatoms above (the average is actually  $0,675 \text{ gN (gC d)}^{-1}$ )
- $V_{Cref}$  =  $0.026 \text{ [mmol N mmolC h}^{-1}]$  Value of  $V_{maxC}$  at  $T_{ref}$   $V_{Cmax}=0.8\text{gN(gC d)}^{-1}$ , average value (Geider *et al*. 1998, table 3,  $Q_N=0.15 \text{ mmolN mmolC}^{-1}$   
 $V_{Cmax} = V_{Cref} [(0.17 - 0.15) / (0.17-0.034)]^n$  where  $n = 0.05$
- $V_{S \text{ ref}}$  =  $0.03 \text{ [mmolSi mmolSi}^{-1} \text{ h}^{-1}]$  value of  $V_{Smax}$  at  $T_{ref}$

Average of the maximum uptake rates (Paasche, 1973):

	Spp1	Spp2	Spp3	Spp4	Spp5
$V_{max}$	0.095	0.073	2.15	26.6	4.09
$Si_{cont}$	5.4	1.81	145	240	550
$V_{max}^s$	= 0.018	= 0.04	= 0.015	= 0.017	0.048

**Where**

- $V_{max \text{ p}}$  = Silicate maximum uptake rate [ $\text{gSi cell h}^{-1}$ ]
- $Si_{cont \text{ p}}$  = average Si content of cells [ $\text{gSi cell}^{-1}$ ]
- $V_{max}^s$  = max Si-specific uptake rate [ $\text{mmolSi mmolSi}^{-1} \text{ h}^{-1}$ ]

## 7. Update pools

Rule 1.26 defines the ammonium pool

### Rule 1.26

$$\text{Ammonium}_{\text{pool}} = \left( \left( \left( \text{Ammonium}_{\text{pool}} + \text{Ammonium}_{\text{ingested}} + \text{Nitrate}_{\text{ingested}} \right) - \left( \text{Ammonium}_{\text{pool}} R_N \text{TimeStep} T_{\text{function}} \right) \right) - \left( \text{if } (Q_N > Q_{N\text{max}}) \text{ then } (0 (Q_N - Q_{N\text{max}})) \text{ else } 0 \right) \right) / C_d$$

where:

$\text{Ammonium}_{\text{pool}}$  = nitrogen pool [mmol N]

$\text{Ammonium}_{\text{ingested}}$  = rate of nitrogen uptake [mmol N h<sup>-1</sup>] during last timestep

$C_d$  = flag for reproduction =1, when ready for division=2 [dimensionless]

$\text{Nitrate}_{\text{ingested}}$  = rate of nitrogen uptake [mmol N h<sup>-1</sup>] during last timestep

$Q_N$  = internal ratio N to C [mmolN mmolC<sup>-1</sup>]

$Q_{N\text{max}}$  = 0.17 [mmolN mmolC<sup>-1</sup>] maximum internal ratio N to C

$R_N$  = 2 10<sup>-3</sup> [mmolN mmolN<sup>-1</sup>h<sup>-1</sup>] N specific rate of N remineralization

TimeStep = 0.5 [h]

$T_{\text{function}}$  = [dimensionless] effect of temperature on metabolic rates

\*Nitrate ingested contributes the ammonium pool

Rule 1.27 set the nitrate pool to zero

### Rule 1.27

$$\text{Nitrate}_{\text{pool}} = 0$$

Rule 1.28 defines the silicate pool

### Rule 1.28

$$\text{Silicate}_{\text{pool}} = \frac{\text{Silicate}_{\text{pool}} + \text{Silicate}_{\text{ingested}}}{C_d}$$

where:

$C_d$  = 1 except when ready for division then =2 [dimensionless] flag for reproduction

$\text{Silicate}_{\text{ingested}}$  = rate of silicate uptake [mmol Si h<sup>-1</sup>] during last timestep

$\text{Silicate}_{\text{pool}}$  = silicon pool [mmol Si]

Rule 1.29 defines the chlorophyll pool:

**Rule 1.29**

$$\text{Chlorophyll}_{\text{pool}} = \max \left[ \left( \left( \left( \text{if } (\text{Theta}_N \leq \text{Theta}_{\text{max}_N}) \text{ then } (\text{Chlorophyll}_{\text{pool}} + (\text{Rho}_{\text{Chl}} (\text{Ammonium}_{\text{ingested}} + \text{Nitrate}_{\text{ingested}}))) \right) \right) \right) \text{else} (\text{Chlorophyll}_{\text{pool}} - (\text{Chlorophyll}_{\text{pool}} - ((\text{Ammonium}_{\text{pool}} + \text{Nitrate}_{\text{pool}}) \text{Theta}_{\text{max}}))) - ((\text{Chlorophyll}_{\text{pool}} \text{R}_{\text{Chl}_N} \text{T}_{\text{function}} \text{TimeStep})) / \text{C}_d), 0 \right]$$

*where:*

- $\text{Ammonium}_{\text{pool}}$  = nitrogen pool [mmol N]
- $\text{Ammonium}_{\text{ingested}}$  = rate of nitrogen uptake [mmol N h<sup>-1</sup>] during last timestep
- $\text{C}_d$  = 1 except when ready for division then =2 [dimensionless] flag for reproduction
- $\text{Chlorophyll}_{\text{pool}}$  = Chlorophyll pool [mg Chl]
- $\text{Nitrate}_{\text{ingested}}$  = rate of nitrogen uptake [mmol N h<sup>-1</sup>] during last timestep
- $\text{Nitrate}_{\text{pool}}$  = nitrogen pool [mmol N]
- $\text{R}_{\text{Chl}_N}$  =  $2 \cdot 10^{-3}$  [mgChl mgChl<sup>-1</sup> h<sup>-1</sup>] Chl specific rate of Chl degradation
- $\text{Rho}_{\text{Chl}}$  = Chl-a synthesis regulation index [mg Chl-a mmolC<sup>-1</sup>]
- $\text{T}_{\text{function}}$  = [dimensionless] effect of temperature on metabolic rates
- $\text{Theta}_{\text{max}_N}$  = 4.2 [mg Chl-a mmolN<sup>-1</sup>] maximum value for the Chl-a:N ratio
- $\text{Theta}_N$  = Chl-a:N ratio [mgChl mmolN<sup>-1</sup>]
- timestep = 0.5 [h]

Rule 1.30 defines the carbon pool:

**Rule 1.30**

$$\text{Carbon}_{\text{pool}} = \frac{(\text{Carbon}_{\text{pool}} + ((\text{Carbon}_{\text{pool}} (\text{P}_{\text{phot}_C} - (\text{R}_C \text{T}_{\text{function}})) \text{TimeStep}) + \text{Carbon}_{\text{pool}}) - 0.0)}{\text{C}_d}$$

*where:*

- $\text{Carbon}_{\text{pool}}$  = carbon pool [mmol C]
- $\text{C}_d$  = 1 except when ready for division then =2 [dimensionless] flag for reproduction
- $\text{P}_{\text{phot}_C}$  = C specific photosynthesis rate at ambient T [mmolC mmolC<sup>-1</sup> h<sup>-1</sup>]
- $\text{R}_C$  =  $2 \cdot 10^{-3}$  [mmolC mmolC h<sup>-1</sup>] C specific rate of respiration
- $\text{T}_{\text{function}}$  = [dimensionless] defines effect of temperature on metabolic rates
- timestep = 0.5 [h]

Rule 1.31 defines the nitrogen pool

**Rule 1.31**

$$\text{Nitrogen}_{\text{pool}} = \text{Ammonium}_{\text{pool}} + \text{Nitrate}_{\text{pool}}$$

## 8. Mortality (natural mortality)

When a diatom dies by energy starvation it metamorphoses from the biological state “living” to the biological state “dead”. It then becomes a particle of detritus. Its chemical pools are then slowly released into solution (see § 10. Remineralization).

Rule 1.32 defines that death for starvation of a diatom occurs when its carbon reserve pool is fully exhausted:

<b>Rule 1.32</b>	
	if ( $\text{Carbon}_{\text{pool}} \leq C_{\text{starve}}$ ), change (Dead)
<i>where:</i>	
$\text{Carbon}_{\text{pool}}$	= carbon pool [mmol C]
$C_{\text{starve}}$	= $8.5 \times 10^{-9}$ [mmol C] carbon content threshold for energy starvation
change	= VEW function (see VEW 3.3 Handbook)

Rule 1.33 set the chlorophyll pool of a dead diatom to 0:

<b>Rule 1.33</b>	
	if ( $\text{Carbon}_{\text{pool}} \leq C_{\text{starve}}$ ), $\text{Chlorophyll}_{\text{pool}} = 0.0$
<i>where:</i>	
$\text{Carbon}_{\text{pool}}$	= carbon pool [mmol C]
$C_{\text{starve}}$	= $8.5 \times 10^{-9}$ [mmol C] carbon threshold for energy starvation
$\text{Chlorophyll}_{\text{pool}}$	= [mg Chl-a]

Rule 1.34 set the carbon pool of a dead diatom to 0:

<b>Rule 1.34</b>	
	if ( $\text{Carbon}_{\text{pool}} \leq C_{\text{starve}}$ ), $\text{Carbon}_{\text{pool}} = 0.0$
<i>where</i>	
$\text{Carbon}_{\text{pool}}$	= carbon pool [mmol C]
$C_{\text{starve}}$	= $8.5 \times 10^{-9}$ [mmol C] carbon threshold for energy starvation
$\text{Chlorophyll}_{\text{pool}}$	= [mg Chl-a]



## From the literature on natural mortality for starvation

Berges and Falkowski (1998) observed that nutrient starvation is more severe than light starvation. After 18 days of nutrient starvation at 18°C the index of photosynthetic capability  $F_v/F_m$  dropped to  $\sim 0$ . They estimate that the carbon threshold for death, in a diatom ready for division, was the carbon left after 18 days of starvation, period in which carbon was burnt to cover basal metabolism.

Field observations on phytoplankton at 40°N 23°W have been interpreted as showing showed that once chlorophyll degradation initiates, cells disintegrate in less than one day (Veldhuis *et al.*, 2001).

In LERM a diatom reaches the threshold for lysis after 18 days at 18°C of only maintenance respiration.

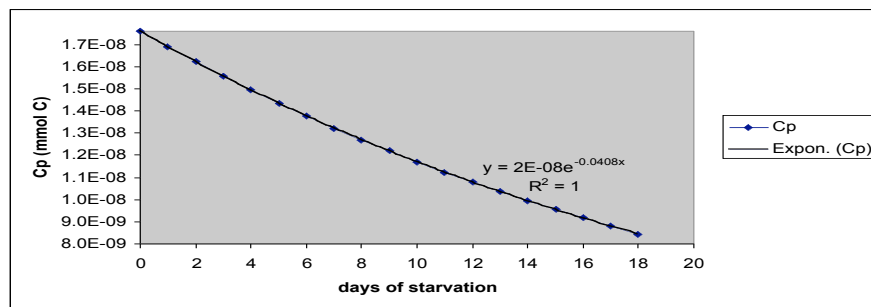

Fig. 1.8 Diatom carbon pool during nutrient starvation

### *Parameters values in the literature*

$C_{starve} = 8.5 \times 10^{-9}$  [mmol C] threshold of carbon content for energy starvation  
Based on Berges and Falkowski (1998) and Veldhuis *et al.* (2001)

## 9. Motility

Diatoms sink through the water at 1 m/day. They are also displaced randomly by turbulence when they are in the mixed layer.

Rule 1.35 defines the displacement of diatoms due to their motility and turbulence:

### *Rule 1.35*

$$z = (\text{if } (z \leq \text{MLDepth}) (\text{rnd} (\text{MLDepth}) + (z_{\text{sink}} \text{TimeStep}) \text{ else } (z + (z_{\text{sink}} \text{TimeStep})))$$

where

$z$	= depth [m]
MLD	= Mixing Layer Depth [m]
rnd	= VEW function, ranges from 0 to MLDepth, (see VEW 3.3 Handbook)
$z_{\text{sink}}$	= 0.04 [m h <sup>-1</sup> ] sinking speed below the turbocline
TimeStep	= 0.5 [h]

---

### From the literature on motility

LERM follows Woods and Barkmann (1994), who assume that a diatom sinks through the water at a constant speed of 1 m day<sup>-1</sup>

---

#### *Parameters values in the literature*

$v_s$  = 0,04 [m h<sup>-1</sup>] sinking velocity below the turbocline (Woods and Barkmann 1994).

## 10. Excretion

Rule 1.36 defines the process of nitrogen excretion:

**Rule 1.36**

release  $((\text{Ammonium}_{\text{pool}} + \text{Nitrate}_{\text{pool}})R_N \text{TimeStep} T_{\text{function}})$ , Ammonium<sub>conc</sub>

where:

release	= VEW function (see VEW 3.3 Handbook)
Ammonium <sub>conc</sub>	= ammonium concentration [mmolN m <sup>-3</sup> ]
Ammonium <sub>pool</sub>	= ammonium pool [mmolN]
R <sub>N</sub>	= 2×10 <sup>-3</sup> [nmol N (mmol N) <sup>-1</sup> h <sup>-1</sup> ] N specific rate of N remineralisation
T <sub>function</sub>	= temperature factor affecting metabolic rates [dimensionless]
TimeStep	= 0.5 [h] t

## 11. Remineralization

Remineralization is defined as the conversion of a chemical in particulate form to dissolved form. During remineralization the chemical leaves the diatom and enters the seawater. There are two processes that affect this transfer:

- (1) Ammonium is released from living diatoms during respiration.
- (2) Ammonium and silicate are released from dead diatoms as the result of microbial action.

The rate of remineralization is proportional to the mass of each chemical in the Droop pool. This leads to an exponential decline in the mass in the Droop pool, like the rule for radioactive decay. Each chemical has an e-folding timescale for remineralization ( $D_{\text{dissolution}}$  and  $N_{\text{dissolution}}$  respectively).

Rule 1.37 defines the process of remineralisation of silicate:

### Rule 1.37

$$Si_{\text{reminT}} = S_{\text{dis}} Q_{\text{RemS}}^{((\text{Temp} + 273) - T_{\text{refS}})/10}$$

where

$Si_{\text{reminT}}$	= silicon specific remineralization rate [ $\text{mmolSi} (\text{mmolSi})^{-1} \text{h}^{-1}$ ]
$Q_{\text{RemS}}$	= 2.27 [dimensionless] Si dissolution factor
$S_{\text{dis}}$	= $8.3 \times 10^{-4}$ [ $\text{nmol} (\text{mmolSi})^{-1} \text{h}^{-1}$ ] Si specific dissolution rate for biogenic Si
Temp	= ambient temperature [ $^{\circ}\text{C}$ ]
$T_{\text{Sref}}$	= 278 [ $^{\circ}\text{K}$ ], reference T for Silicate dissolution
10	= delta temperature

Rule 1.38 defines the process of remineralisation of ammonium:

### Rule 1.38

$$N_{\text{reminT}} = N_{\text{dis}} Q_{\text{RemN}}^{((\text{Temp} + 273) - T_{\text{refN}})/10}$$

Where:

$N_{\text{reminT}}$	= nitrogen specific remineralization rate [ $\text{mmolN} (\text{mmolN})^{-1} \text{h}^{-1}$ ]
$Q_{\text{RemN}}$	= 2.95 [dimensionless] N dissolution factor
$N_{\text{dis}}$	= $4.2 \times 10^{-4}$ [ $\text{nmol} (\text{mmolN})^{-1} \text{h}^{-1}$ ] Si specific dissolution rate of N
Temp	= ambient temperature [ $^{\circ}\text{C}$ ]
$T_{\text{Nref}}$	= 283 $^{\circ}\text{K}$ Reference T for Silicate remineralisation
10	= delta temperature

Rule 1.39 defines the release of silicate in the water:

<p><b>Rule 1.39</b></p> <p style="text-align: center;"><math>\text{release}((\text{Silicate}_{\text{pool}} \text{Si}_{\text{reminT}} \text{TimeStep}), \text{Silicate}_{\text{Conc}})</math></p> <p><i>where:</i></p> <p>release = VEW function (see VEW 3.3 Handbook)</p> <p>Silicate<sub>Conc</sub> = silicate in the water [mmolSi]</p> <p>Silicate<sub>pool</sub> = silicate pool [mmolSi]</p> <p>TimeStep = 0.5 [h]</p>
--

Rule 1.40 defines the silicate pool:

<p><b>Rule 1.40</b></p> <p style="text-align: center;"><math>\text{Silicate}_{\text{pool}} = \max((\text{Silicate}_{\text{pool}} - (\text{Silicate}_{\text{pool}} \text{Si}_{\text{reminT}} \text{TimeStep})), 0.0)</math></p> <p><i>where:</i></p> <p>Silicate<sub>pool</sub> = silicate pool [mmolSi]</p> <p>Si<sub>reminT</sub> = silicon specific remineralization rate [mmolSi (mmolSi)<sup>-1</sup> h<sup>-1</sup>]</p> <p>TimeStep = 0.5 [h]</p>
---

Rule 1.41 defines the release of ammonium and nitrate in the water:

<p><b>Rule 1.41</b></p> <p style="text-align: center;"><math>\text{release}((\text{Ammonium}_{\text{pool}} + \text{Nitrate}_{\text{pool}}) \text{N}_{\text{reminT}} \text{TimeStep}), \text{Ammonium}_{\text{Conc}})</math></p> <p><i>where:</i></p> <p>release = VEW function (see VEW 3.3 Handbook)</p> <p>Ammonium<sub>Conc</sub> = ammonium in the water [mmolN]</p> <p>Ammonium<sub>pool</sub> = ammonium pool [mmolN]</p> <p>N<sub>reminT</sub> = nitrogen specific remineralization rate [mmolN (mmolN)<sup>-1</sup> h<sup>-1</sup>]</p> <p>TimeStep = 0.5 [h]</p>
---

Rule 1.42 defines the ammonium pool:

<p><b>Rule 1.42</b></p> <p style="text-align: center;"><math>\text{Ammonium}_{\text{pool}} = \max((\text{Ammonium}_{\text{pool}} - (\text{Ammonium}_{\text{pool}} \text{N}_{\text{reminT}} \text{TimeStep})), 0.0)</math></p> <p><i>where:</i></p> <p>Ammonium<sub>pool</sub> = nitrogen pool [mmolN]</p> <p>N<sub>reminT</sub> = nitrogen specific remineralization rate [mmolN (mmolN)<sup>-1</sup> h<sup>-1</sup>]</p> <p>TimeStep = 0.5 [h]</p>
---

Rule 1.43 defines the nitrate pool:

<p><b>Rule 1.43</b></p> <p style="text-align: center;"><math>\text{Nitrate}_{\text{pool}} = \max((\text{Nitrate}_{\text{pool}} - (\text{Nitrate}_{\text{pool}} \text{N}_{\text{reminT}} \text{TimeStep})), 0.0)</math></p> <p><i>where:</i></p> <p>Nitrate<sub>pool</sub> = nitrogen pool [mmolN]</p> <p>N<sub>reminT</sub> = nitrogen specific remineralization rate [mmolN (mmolN)<sup>-1</sup> h<sup>-1</sup>]</p> <p>TimeStep = 0.5 [h]</p>
---

*Parameters values in the literature*

- $A_{\text{conc}}$  = ammonium concentration
- $N_{\text{dissolution}}$  = 0.0042 [mmolN (mmolN h)<sup>-1</sup>] N specific dissolution rate of N  
From Heath *et al.* (1997)
- $Q_{\text{RemN}}$  = 2.95 [dimensionless] N dissolution factor increase with T  
From Heath *et al.* (1997)
- $Q_{\text{RemS}}$  = 2.27 [dimensionless] Si dissolution factor increases with T (K)  
From Kamatani (1982)
- $R_{\text{N}}$  =  $2 \times 10^{-3}$  [nmol N (mmol N)<sup>-1</sup> h<sup>-1</sup>] N specific rate of N remineralisation  
From Geider *et al.* (1996)
- $S_{\text{dissolution}}$  =  $8.3 \times 10^{-4}$  [nmolSi (mmolSi h)<sup>-1</sup>] Si specific dissolution rate for biogenic Si  
From Hurd & Birdwhistell (1983)
- $T_{\text{Nref}}$  = 283 °K reference T for Silicate remineralisation  
From Heath *et al.* (1997)
- $T_{\text{Sref}}$  = 278 °K reference T for Silicate dissolution  
From Hurd & Birdwhistell (1983)
- $T_{\text{function}}$  = temperature factor used to modulate metabolic rates [dimensionless], Geider (1996)

## 12. Calculating the Geider quotas

Rule 1.44 diagnostic rule to calculate the Geider quotas (Chlorophyll to Carbon ratio) used in photoadaptisation:

*Rule 1.44*

$$\text{Chl to } C_{\text{pool}} = (\text{if } (\text{Carbon}_{\text{pool}} > 0.0) \text{ then } \frac{\text{Chlorophyll}_{\text{pool}}}{\text{Carbon}_{\text{pool}}} \text{ else } 0.0)$$

Rule 1.45 diagnostic rule to calculate the Geider quotas (Nitrogen to Carbon ratio) used in photoadaptisation:

*Rule 1.45*

$$\text{N to } C_{\text{pool}} = (\text{if } (\text{Carbon}_{\text{pool}} > 0.0) \text{ then } \frac{\text{Nitrogen}_{\text{pool}}}{\text{Carbon}_{\text{pool}}} \text{ else } 0.0)$$

## **PART 2 – Herbivorous zooplankton**

Design considerations .....	66
Overview for Herbivores .....	71
State variables for Herbivores .....	72
Parameters for Herbivores .....	73
Chemical pools for Herbivores .....	75
Staged growth for Herbivores.....	76
Biological rules for Herbivores.....	77
1. Copepod size.....	77
2. Effect of temperature and size on copepod swimming speed.....	80
3. Diel migration.....	81
4. Foraging .....	83
5. Swimming direction.....	85
6. Migration during diapause .....	86
7a. Migration out of diapause for OWA4.....	87
7b. Migration out of diapause for OWA5.....	88
8. Motility .....	89
9. Sinking of corpses.....	90
10. Gut volume .....	91
11. Respiration: basal metabolic cost.....	93
12. Respiration: Swimming cost .....	94
13a. Preparing for diapause as OW4.....	96
13b. Preparing for diapause as OW5.....	97
14. Preparing for diapause as C4OW .....	98
15a. Starting diapause as POW4 .....	99
15b. Starting diapause as POW5 .....	99
16a. Diapause OW4.....	100
16b. Diapause OW5.....	100
17. Ingestion.....	102
18. N specific assimilation efficiency .....	106
19. Egestion .....	107
20. Fæcal pellet.....	108
21. Assimilation of ammonium.....	111
22. Respiration: specific dynamic action cost.....	112
23. Energetics.....	113



24. Energetics during diapause .....	114
25a. Start descent to diapause for OWD4 .....	115
25b. Start descent to diapause for OWD5 .....	116
26. Become adult.....	117
27. Become mature .....	117
28. Naupliar mortality counter .....	117
29. Pellet sinking.....	118
30a. Turn POW4 into C4OW .....	119
30b. Turn POW5 into C5.....	119
31. Update gut content.....	119
32. Update depth .....	120
33. Allocation of assimilated carbon .....	121
33a. Allocation of carbon to storage 1 .....	123
33b. Allocation of carbon to storage 2 .....	123
33c. Allocation of carbon storage 3 .....	123
33d. Allocation of carbon to carapace.....	123
34. Lipid pool .....	124
35. Protein pool .....	125
36. Carapace C pool .....	126
37. Total carbon.....	126
38. Ammonium pool.....	126
39. Nitrate pool .....	127
40. Total nitrogen.....	127
41. Silicate pool .....	127
42. Reproduction .....	128
43. Eggs production.....	130
44. Naupliar mortality .....	131
45. Metamorphosis of N3, N4, N5 .....	131
46. Metamorphosis of N6, C1, C2 .....	131
47. Metamorphosis of C5 .....	131
48. Mortality due to starvation .....	132
49. Mortality due to senescence.....	132
50. Excretion.....	133
51. Remineralisation .....	134

## Design considerations

As with the phytoplankton, the herbivorous zooplankton in LERM are conceptually like the copepods in the WB model. Some of the biological functions are the same, others are new. The principal novelty lies in

- (1) staged growth, which follows that of Carlotti & Wolf (1998),
- (2) digestion, and
- (3) biochemistry (with lipid, protein and chitin).

## Choice of species

LERM has a single species of herbivores based on *Calanus finmarchicus*. The biological functions of this species have been studied in detail by marine biologists who have published phenotypic equations derived from experiments performed under controlled conditions. The species is common in the Azores, the site of numerical experiments designed to reveal the characteristics of an LERM virtual ecosystem. These copepods are known to be the principal food of plankton squid.

## Staged growth

LERM copepods have staged growth based on the (Lagrangian Ensemble) model of Carlotti & Wolf (1998)<sup>9</sup>. The design exploited the facility in VEW 3.3 to designate any number of biological states for a functional group (this was described on p. 23). In LERM, the copepods constitute one functional group, which has only one species, based on *Calanus finmarchicus*. LERM allocates a unique biological state to each growth stage of those copepods.

In the LE metamodel, all the plankters in one functional group have an identical set of biological functions. Each function is defined by one or more phenotypic rules and associated parameters. All plankters in a functional group have the same set of phenotypic rules. That is true regardless of their biological state. However, the biological states have different values for their phenotypic parameters. That is what distinguishes one biological state from another. It is used in all functional groups to distinguish between living and dead states. In the case of LERM copepods, the growth stages are distinguished by the values of their phenotypic parameters. That opens they way to a number of design features.

## Copepod size

First it allows us to define a unique size for each stage. A copepod changes size when it metamorphoses from one growth stage to the next. So a copepod's size depends on the size of its shell, which is discarded when it

---

<sup>9</sup> Uli Wolf's was John Woods's PhD student at IFM Kiel in the mid-1980s. His PhD project added copepods to the Woods-Onken LE model (which had no grazers). The result was subsequently refined to become the WB model. That was used for all virtual ecology research in the UK until the LERM replaced it in 2007. The copepods in WB did not have staged growth.

moult. Its size does not depend on the masses of chemicals in its Droop pools.

### **Swimming speed**

The copepod's growth stage determines its maximum swimming. Its actual swimming speed and direction are computed using phenotypic rules that are functions of that maximum and other variables, such as satiation (see below).

### **Behaviour**

In principle, all stages of the *copepod* functional group can perform diapause (seasonal migration). But by prescribing different values for the diapause parameters in each growth stage, the modeller can limit diapause to selected stages only. Other behaviour functions, such as foraging and diel migration, can be turned on or off for individual copepod stages.

### **Risk of being eaten**

Some of the parameters in the functional group determine the copepod's vulnerability to being eaten by a carnivore (in LERM these are squid or top predators). By setting the values of these vulnerability parameters to different values for different growth stages, the modeller can specify which stages of a copepod will be eaten by a predator.

That opens the way for specifying *food preference* in the predators. For example, the modeller can specify that squid in a certain size range (determined by *their own* growth stage) will only eat copepods of a given stage. And the carnivore's ingestion rules can be written to specify that when it is hungry (defined by its satiation index) it will also eat copepods in other stages, or even dead copepods or copepod faecal pellets. So modelling food preference is achieved by setting parameters values in both the predator and prey.

### **Droop pools**

A copepod has Droop pools for every chemical in the model (that is a requirement of VEW 3.3). However only a few of those pools are active in the copepods. These contain carbon in three forms, lipid, protein and chitin; and organic nitrogen in the pool labelled ammonium (this is a computational convenience). The pools receive carbon and nitrogen respectively from the transfer pools for ingested carbon and nitrogen.

### **Respiration**

LERM contains phenotypic rules for reduction of carbon in the lipid and protein pools at rates that depend on the copepod's stage and respiration (due to digestion and swimming) plus a cost-of-living overhead.

### **Starvation**

The LERM copepod dies by starvation when the lipid and protein pools decline by a prescribed amount, which is stage dependent.

## **Cannibalism**

Unlike those in the WB model, the LERM copepods do not perform cannibalism to reduce the rate of loss by starvation. That is an option that could easily be included if needed for other applications.

## **Gut passage time**

All living zooplankton, including copepods, have a prescribed maximum gut capacity. A copepod stops grazing when its gut is full. The gut passage time is defined as the time taken to empty a full gut, when there is no ingestion. Values of gut passage time for each growth stage are model parameters. They are derived from the marine biology literature. They are typically of order one hour.

## **Digestion**

While food is in the copepod's gut the ingested chemicals are allocated to other Droop pools. For example, the organic carbon in an ingested diatom is allocated to the lipid, protein and chitin pools at rates that are determined by phenotypic rules. The proportions depend on the copepod's growth stage. For example, those in the pre-wintering stage (preparing for diapause) allocate 100% of the ingested carbon to lipid, which becomes the essential food during winter when the copepod stops feeding on diatoms.

## **Egestion**

Some of the carbon in an ingested diatom may remain undigested at the completion of the prescribed gut passage time. That residual is egested as a faecal pellet, which is carried by a new computer agent. LERM faecal pellets have a fixed C:N ratio. So it is likely that the faecal pellet will not have the capacity to carry all the ingested nitrogen.

## **Excretion**

That excess nitrogen is excreted directly into solution as ammonium.

## **Grazing**

The LERM herbivores graze on diatoms. The demand for food depends on the size of the copepod (i.e. its growth stage), and on the space in its gut. VEW 3.3 automatically computes the total demand for diatoms in each layer during one time step, by summing the demand of the sub-population in each copepod agent present in (or passing through) the layer.

## Satiation

If the ambient concentration<sup>10</sup> of diatoms is sufficient to satisfy the demand of all copepods, then every copepod grazing in the layer ingests the number of diatoms it needs to refill its gut. The copepods are then satiated. If the diatoms concentration in a layer is insufficient, then the available food is distributed among the grazers. This automatic procedure performed by VEW3.3 avoids over-depletion of the prey. And, in this case, it is not sufficient to refill the copepods' guts, so the copepods are not satiated. VEW 3.3 automatically computes the satiation index for every copepod, on the basis of the fraction of its gut that remains unfilled at the end of each time step. The index ranges from zero for an empty gut to one for a full gut. It is a measure of how hungry the copepod is.

## Adaptive behaviour

As in the WB model, LERM copepods adapt their behaviour according to how hungry they are, using phenotypic rules based on their satiation index. This capability is used to adapt diel migration. If it is hungry, a copepod delays its forenoon descend and re-ascends earlier in the afternoon. That increases the fraction of time in each 24-hours for grazing in relatively shallow water (mixed layer or deep chlorophyll maximum) and reduces the fraction of time spend in deep water where there is no food. The net effect is to reduce the risk of starvation, while increasing the risk of being seen and eaten by visual predators (the squid in LERM).

## Diel migration

The phenotypic rule controlling diel migration in LERM copepods followed that used previously in the WB model. The copepod descends in the forenoon and re-ascends in the afternoon. It does so by pursuing a target isolume. The value of the target isolume typically has a PAR irradiance of a few Watt/m<sup>2</sup>. The actual value depends on two factors: the copepod's size (its growth stage) and its satiation index. We assume that natural selection has optimized the irradiance value of the target isolume. It is the result of a demographic trade between death rates by starvation, on the one hand, and being eaten, on the other. Demography is an emergent property of LE virtual ecosystems. So the optimal target isolume can be established by numerical experiments. LERM adopts the results of optimization experiments performed on WB virtual ecosystems at the Azores.

---

<sup>10</sup> The ambient concentration of prey in Lagrangian Ensemble models is defined by the concentration in the layer where the predator resides, or through which the migrating predator passes during the (half-hour) time step. The prey concentration is computed by summing over the sub-populations of prey agents that are present in the layer; or, if the prey are migrating, passing through the layer. This computation is performed automatically by VEW3.3. There is no need for the modeller to write equations for computing prey concentration.

## Diapause

LERM adopts the diapause rules published by Carlotti & Wolf (1998). Some of the copepods in growth stages 3 and 4 prepare for over-wintering in deep water by filling their lipid pools. When ready they descend into deep water, where they stop diel migration, foraging and reduce their respiration. They return to the surface on a prescribed date.

## Foraging

LERM copepods follow the foraging rule developed for the WB model. It is invoked when the ambient irradiance is below that of their target isolume (mainly at night). The rule leads a copepod reverse its swimming direction (up or down in a one-dimensional model) when the ambient concentration of food (i.e. diatoms) decreases. This is particularly important for copepods feeding in the seasonal thermocline, where diatoms are concentrated in a chlorophyll maximum, which is characterized by complex fine structure with several maxima in the concentration profile. Remember that copepod feeding during summer oligotrophy (when diatoms are found mainly in the deep chlorophyll maximum) is particularly important for fisheries recruitment, which was the original application of LERM.

## Reproduction

LERM copepods reach maturity after stage six. They then divert ingested carbon to making eggs. The number of eggs produced by a copepod depends on how well it feeds while in this mature. The stage ends after a prescribed period (20 days in LERM). The eggs are then transferred to a new computer agent, where they start as stage N3, and subsequently progress through the growth stage chain, unless death by starvation or predation intervenes.

## Senility

After the eggs hatch the mother copepod metamorphoses into the *Senile* stage. It continues to graze of diatoms, and resumes allocating the ingested carbon to lipids and protein. While in this stage the copepod continues to be the prey of squid and top predators. However, the number of copepods in the subpopulation of each computer agent decreases linearly until it is zero after a prescribed period of time (20 days in LERM). This procedure of *senile mortality* ensures that individual copepods breed only once.

## Overview for Herbivores

The zooplankton species is based on *Calanus finmarchicus*. LERM assumes that all copepods are female. The phenotypic equations for stage growth were derived mainly from Carlotti and Wolf (1998).

Copepods reach the maturity, a prescribed threshold mass of the protein pool, after a number of grow stages. Metamorphosis from one stage to the next is triggered by size (i.e. protein pool).

The copepod physiological state is determined by biological state variables: carbon pool including proteins (nitrogenous carbon), lipids (non-nitrogenous carbon) and carapace (chitin), nitrogen pool, gut content, gut fullness, gut volume, stage and age.

## State variables for Herbivores

Carbon <sub>pool</sub>	= carbon pool [mmol C]
C <sub>N</sub>	= proteins (nitrogenous carbon pool) [mmol C]
C <sub>NN</sub>	= lipids (non nitrogenous carbon pool) [mmol C]
C <sub>shell</sub>	= chitin (carbon in carapace) [mmol C]
Nitrogen <sub>pool</sub>	= Nitrogen pool [mmol N]
Gut content	= volume of prey in the gut at the end of time step [mm <sup>3</sup> ]
Gut fullness	= index, v 0=gut empty to 1=gut full [dimensionless]
Gut volume	= [mm <sup>3</sup> ]
Stage	= [dimensionless]
Age	= [h]



## Parameters for Herbivores

Name in equation editor	Description	Value	Units	Source
a	N specific prey digestion rate	1.584	h <sup>-1</sup>	Caparroy & Carlotti, 1996
A <sub>rep</sub>	Age at fecundity	480	h	Woods&Barkmann, 1994
A <sub>max</sub>	Maximum lifespan since reaching reproductive maturity	960	h	Woods&Barkmann, 1994
B	C specific prey digestion rate	1.584	h <sup>-1</sup>	Assumed as 'a'
C1 <sub>min</sub>	Threshold for entering stage C1	6.25 x10 <sup>-5</sup>	mmolC	Carlotti & Wolf, 1998
C2 <sub>min</sub>	Threshold for entering stage C2	9.15 x10 <sup>-5</sup>	mmolC	Carlotti & Wolf, 1998
C3 <sub>min</sub>	Threshold for entering stage C3	2.1 x10 <sup>-4</sup>	mmolC	Carlotti & Wolf, 1998
C4 <sub>min</sub>	Threshold for entering stage C4	5.8 x10 <sup>-4</sup>	mmolC	Carlotti & Wolf, 1998
C5 <sub>min</sub>	Threshold for entering stage C5	1.25 x10 <sup>-3</sup>	mmolC	Carlotti & Wolf, 1998
C6 <sub>min</sub>	Threshold for entering stage C6	3.33 x10 <sup>-3</sup>	mmolC	Carlotti & Wolf, 1998
C <sub>Cal</sub>	Oxycaloric coefficient	20.3	kJ l <sup>-1</sup>	Ikeda <i>et al.</i> ,2000
C <sub>conv1</sub>	C conversion factor mmol to µg	12000	µgC mmolC <sup>-1</sup>	calculated
Delta	Reduction of basic metabolism in hibernating copepods	0.20	dimensionless	Carlotti & Wolf, 1998
E <sub>m</sub>	Muscular efficiency of copepod	0.25	dimensionless	Caparroy & Carlotti, 1996
E <sub>mech</sub>	Mechanical efficiency of swimming copepod	0.30	dimensionless	Caparroy & Carlotti, 1996
G <sub>max</sub>	Maximum C content of an individual	8.33 x10 <sup>-3</sup>	mmolC	Woods & Barkmann,1994
G <sub>min</sub>	Weight of newly born nauplii	1 x10 <sup>-5</sup>	mmolC	Woods & Barkmann,1994
I <sub>ref</sub>	Reference irradiance	1.0	W m <sup>-2</sup>	Woods & Barkmann,1994
K	Coeff. of empirical relationship between drag coefficient and Reynolds number	85.2	dimensionless	Caparroy & Carlotti, 1996
mi	Seawater dynamic viscosity	11.9 x10 <sup>-3</sup>	g m <sup>-1</sup> s <sup>-1</sup>	Caparroy & Carlotti, 1996
n	Coeff. of empirical relationship between drag coefficient and Reynolds number	0.8	dimensionless	Caparroy & Carlotti, 1996
N4 <sub>min</sub>	Threshold for entering N4 stage	1.7 x10 <sup>-5</sup>	mmolC	Carlotti & Wolf, 1998
N5 <sub>min</sub>	Threshold for entering N5 stage	2.5 x10 <sup>-5</sup>	mmolC	Carlotti & Wolf, 1998
N6 <sub>min</sub>	Threshold for entering N6 stage	3.75 x10 <sup>-5</sup>	mmolC	Carlotti & Wolf, 1998
N <sub>mp</sub>	Chances of naupliar mortality	0.9	dimensionless	Woods &Barkmann, 1994
OW <sub>lipid</sub>	Lipid content needed to overwinter	6.33 x10 <sup>-3</sup>	mmolC	Carlotti & Wolf, 1998
Pre <sub>OW4</sub>	Minimum C content to pre-overwinter	5.80 x10 <sup>-4</sup>	mmolC	Carlotti & Wolf, 1998
Pre <sub>OW5</sub>	Minimum C content to overwinter as C5	1.25 x10 <sup>-3</sup>	mmolC	Carlotti & Wolf, 1998

LERM – Technical documentation

$Q_{N\_max}$	Maximum N:C ratio	0.23	$\text{mmoNmmolC}^{-1}$	Huntley&Nordhausen,1995
$Q_{nProt}$	Fixed N:C ratio in proteins	0.27	$\text{mmoNmmolC}^{-1}$	Anderson <i>et al.</i> , 2005
$QR_{-10}$	increase of metabolism for 10°C temperature increase over $T_{ref}$	3.4	dimensionless	Carlotti & Wolf, 1998
$r_{bas}$	Basal metabolic coefficient	$4.17 \times 10^{-4}$	$\text{h}^{-1}$	Carlotti & Wolf, 1998
$r_{sda}$	Specific Dynamic Action coeff.	0.17	dimensionless	Kjørboe <i>et al.</i> , 1985
$S_{max}$	Max cross-sectional area	$1.3 \times 10^{-3}$	$\text{cm}^{-2}$	estimated from Caparroy & Carlotti, 1996
$t_{max}$	Maximum gut passage time	1.08	h	Caparroy & Carlotti, 1996
$t_{min}$	minimum gut passage time	0.58	h	Caparroy & Carlotti, 1996
$T_{ref}$	Reference temperature	10	°C	Carlotti & Wolf, 1998
$V_{max}$	Maximum swimming speed	45	$\text{mh}^{-1}$	Woods & Barkmann, 1994
$V_{mconv1}$	Swimming velocity conversion factor: m/h to cm/s	0.0278	$\text{cm h m}^{-1} \text{s}^{-1}$	calculated
$Vol_{conv1}$	Conversion coefficient $\text{mm}^3$ to $\text{m}^3$	$1 \times 10^{-9}$	$\text{m}^3 \text{mm}^{-3}$	calculated
$vol_{gut}$	mid-gut growth coefficient	$1.5 \times 10^{-8}$	$\text{cm}^3 \mu\text{m}^{-1}$	estimated from Caparroy and Carlotti,1996
$V_{Prey}$	Fixed diatom volume	$4.2 \times 10^{-9}$	$\text{cm}^3$	estimated from Menden-Deuer & Lessard, 2000
$Z_{start OW}$	Depth at which diapause starts	400	m	assumed

## Chemical pools for Herbivores

Assimilated carbon is dynamically allocated to lipids, proteins and carapace in different ratios depending on the life stage.

The amount of ingested carbon allocated to lipid reserve per time step depends on the state of development.

a	Min	Max	Units	Functions	Reference
Carbon	$10^{-5}$	Not fixed	mmol C	State variable	Carlotti & Wolf, 1998
Protein	$4.75 \times 10^{-6}$	$8.33 \times 10^{-3}$	mmol C	State variable	Carlotti & Wolf, 1998
Lipid	$4.75 \times 10^{-6}$	Not fixed	mmol C	State variable	Carlotti & Wolf, 1998
Shell	$5.00 \times 10^{-7}$	$4.20 \times 10^{-4}$	mmol C	State variable	Carlotti & Wolf, 1998
Nitrogen	$1.20 \times 10^{-6}$	23% of C	mmol N	State variable	Huntley&Nordhausen, 1995
b	Min	Max	Units	Functions	Reference
N:C	0.12	0.23	mmol N: mmol C	Excretion	Huntley&Nordhausen, 1995

Table 2.1 Stage independent: a) stoichiometry and b) cellular ratios of chemicals.

The ratio of N:C ( $Q_{Nprot}$ ) for proteins is assumed to be constant,  $Q_{Nprot} = 0.27$  mmolN mmolC<sup>-1</sup> (Anderson *et al.*, 2005)

According to Huntley and Nordhausen (1995) The total amount N is regulated by the minimum and maximum of the ratio N:C ( $Q_N$ ),

$$Q_{Nmin} = 0.12 \text{ mmolN mmolC}^{-1}$$

$$Q_{Nmax} = 0.23 \text{ mmolN mmolC}^{-1}$$

## Staged growth for Herbivores

We noted in the section INTRODUCTION of this technical documentation (see p.22) that VEW 3.3 supports staged growth in zooplankton.

The diagram shows the copepod stages. Red arrows indicate the creation of a new agent. OW4A and OW5A migrates to the surface waters after the diapause in deep waters.

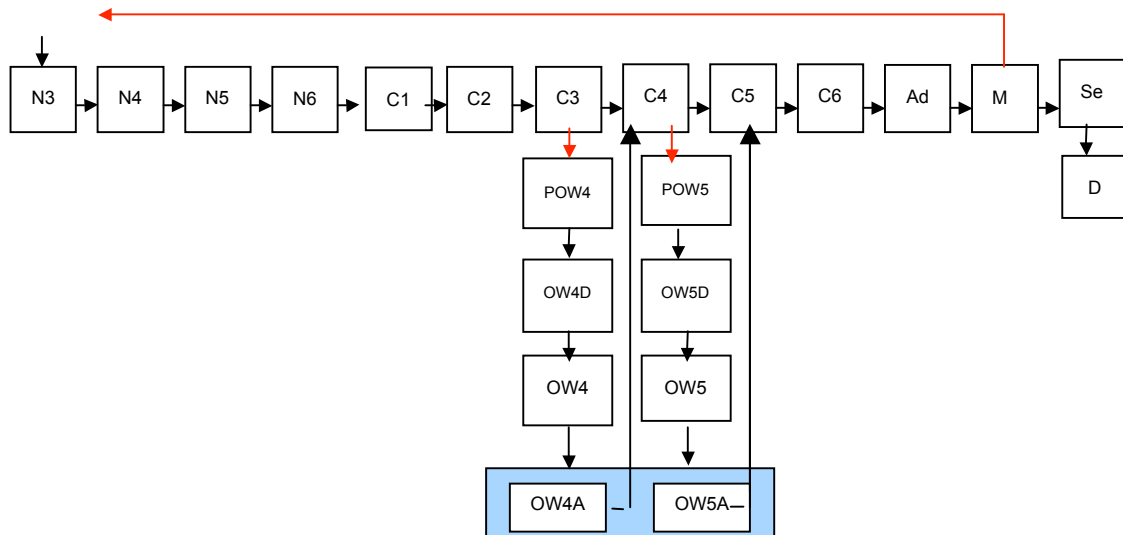

In LERM, the biological state of a copepod is determined by two factors: (i) its growth stage, and (ii) the mass of chemicals in each of its Droop pools. These are the factors that are used in phenotypic rules to update the biological state of a copepod at each time step in the integration. One rule determines when the copepod will metamorphose from its current growth stage to the next.

LERM does not include a respiration cost of metamorphosis. All the chemicals in the Droop pool are inherited in the next stage. LERM does feature moulting, since it was not needed for the fisheries recruitment project. VEW 3.3 supports this procedure). It would be trivial to add tracking of moulted carapace. It would be needed, for example, in modelling cholera.

## Biological rules for Herbivores

### 1. Copepod size

Rule 2.1 defines the copepods length according to Uye (1982):

<i>Rule 2.1</i>	
	$C_{pmax} = (\text{if } (C_{N\_Pool} > C_{pmax}) \text{ then } C_{N\_Pool} \text{ else } C_{pmax})$
<i>where:</i>	
$C_{pmax}$	= maximum obtained protein pool [mmol C]
$C_{N\_Pool}$	= lipid pool [mmol C]

Rule 2.2 defines the copepods length according to Uye (1982):

<i>Rule 2.2</i>	
	$L = 10^{(\log_{10}(C_{pmax}C_{conv1}))+8.37)/3.07}$
<i>where:</i>	
$L$	= prosome length [ $\mu\text{m}$ ]
$C_{pmax}$	= maximum obtained protein pool [mmol C]
$C_{conv1}$	= 12000 [ $\mu\text{g mmol C}^{-1}$ ] conversion factor mmol to $\mu\text{g}$

Rule 2.3 defines the copepods volume following Mauchline (1998)

<i>Rule 2.3</i>	
	$\text{Body}_{vol} = (10^{((3.164\text{Log}(L)-10.69)}) \text{Vol}_{conv1})$
<i>where:</i>	
$\text{Body}_{vol}$	= body volume [ $\text{mm}^3$ ]
$L$	= Prosome length [ $\mu\text{m}$ ]
$\text{Vol}_{conv1}$	= $1 \times 10^{-9}$ [ $\text{m}^3 \text{mm}^{-3}$ ] converts $\text{mm}^3$ to $\text{m}^3$

Rule 2.4 defines the surface area of a copepod following Vlymen's (1970)

<i>Rule 2.4</i>	
	$S = (L \ 5.4 \ E-7)$
<i>where:</i>	
$S$	= surface area [ $\text{cm}^2$ ]
$L$	= Prosome length [ $\mu\text{m}$ ]
$5.4 \ E-7$	= coefficient to link surface area [ $\text{cm}^2$ ] to prosome length [ $\mu\text{m}$ ]
* $E-7 = 10^{-7}$	

## From the literature on copepod staged growth

The model for copepod staged growth is derived from Carlotti and Wolf (1998). Table 2.2:

Stage	Description	ID #	Protein threshold [mmol C]	Proso me length L [mm]	Frontal Area S [cm <sup>2</sup> ]	Body volume [mm <sup>3</sup> ]	Max swim speed at 10°C [m/h]
N3	Nauplius III	0	1.00 x10 <sup>-5</sup>	0.27	1.46x10 <sup>-4</sup>	1.00x10 <sup>-3</sup>	5.09
N4	Nauplius IV	1	1.70 x10 <sup>-5</sup>	0.32	1.70x10 <sup>-4</sup>	1.64x10 <sup>-3</sup>	5.93
N5	Nauplius V	2	2.50 x10 <sup>-5</sup>	0.36	1.94x10 <sup>-4</sup>	2.50x10 <sup>-3</sup>	6.77
N6	Nauplius VI	3	3.7 5x10 <sup>-5</sup>	0.41	2.22x10 <sup>-4</sup>	3.79x10 <sup>-3</sup>	7.74
C1	Copepodite I	4	6.25 x10 <sup>-5</sup>	0.48	2.62x10 <sup>-4</sup>	6.42x10 <sup>-3</sup>	9.14
C2	Copepodite II	5	9.20 x10 <sup>-5</sup>	0.55	2.97x10 <sup>-4</sup>	9.53x10 <sup>-3</sup>	10.30
C3	Copepodite III	6	2.10 x10 <sup>-4</sup>	0.72	3.88x10 <sup>-4</sup>	2.22x10 <sup>-2</sup>	13.53
POW4	Pre-overwintering CIV	7	5.83 x10 <sup>-4</sup>	1.00	5.42x10 <sup>-4</sup>	6.42x10 <sup>-2</sup>	18.91
POW5	Pre-overwintering CV	8	1.25 x10 <sup>-3</sup>	1.29	6.95x10 <sup>-4</sup>	0.14	24.24
OWD4	Overwintering descent CIV	9	5.83 x10 <sup>-4</sup>	1.00	5.42x10 <sup>-4</sup>	6.42x10 <sup>-2</sup>	18.91
OWD5	Overwintering descent CV	10	1.25 x10 <sup>-3</sup>	1.29	6.95x10 <sup>-4</sup>	0.14	24.24
OW4	Overwintering CIV	11	5.83 x10 <sup>-4</sup>	1.00	5.42x10 <sup>-4</sup>	6.42x10 <sup>-2</sup>	18.91
OW5	Overwintering CV	12	1.25 x10 <sup>-3</sup>	1.29	6.95x10 <sup>-4</sup>	0.14	24.24
OWA4	Overwintering ascent CIV	13	5.83 x10 <sup>-4</sup>	1.00	5.42x10 <sup>-4</sup>	6.42x10 <sup>-2</sup>	18.91
OWA5	Overwintering ascent CV	14	1.25 x10 <sup>-3</sup>	1.29	6.95x10 <sup>-4</sup>	0.14	24.24
C4	Copepodite IV	15	5.83 x10 <sup>-4</sup>	1.00	5.42x10 <sup>-4</sup>	6.42x10 <sup>-2</sup>	18.91
C4OW	Copepodite IV after OW	16	5.83 x10 <sup>-4</sup>	1.00	5.42x10 <sup>-4</sup>	6.42x10 <sup>-2</sup>	18.91
C5	Copepodite V	17	1.25 x10 <sup>-3</sup>	1.29	6.95 x10 <sup>-4</sup>	0.14	24.24
C6	Copepodite VI	18	3.33 x10 <sup>-3</sup>	1.77	9.56 x10 <sup>-4</sup>	0.39	33.35
Ad	Adult	19	7.50 x10 <sup>-3</sup>	2.31	1.25 x10 <sup>-3</sup>	0.89	43.40
Ma	Mature	21	8.33 x10 <sup>-3</sup>	2.39	1.29 x10 <sup>-3</sup>	1.00	45.00
Se	Senescent	22	----	2.39	1.29 x10 <sup>-3</sup>	1.00	45.00
Nauplius	Nauplius	20					
P	Pellet	23					
D	Dead	24					

***Parameters values in the literature***

$$\text{Log Body}_{\text{vol}} [\text{mm}^3] = 3.164 \log L [\mu\text{m}] - 10.690$$

Body volume from prosome length L (Mauchline, 1998; regression equation  $r = 0.972$ )

$$\text{Conversion coefficient} = 1.3 \times 10^{-3} \text{ cm}^2 / 2400 \mu\text{m} = \sim 5.4 \times 10^{-7} \text{ cm}^2 \mu\text{m}^{-1}$$

Relationship between prosome length and surface frontal area (Vlymen's 1970). An adult copepod has a prosome length of  $\sim 2.4 \text{ mm}$  and a surface frontal area of  $\sim 1.4 \times 10^{-3} \text{ cm}^2$ . Assuming a linear relationship, then the conversion coefficient =  $1.3 \times 10^{-3} \text{ cm}^2 / 2400 \mu\text{m} = \sim 5.4 \times 10^{-7} \text{ cm}^2 \mu\text{m}^{-1}$

## 2. Effect of temperature and size on copepod swimming speed

Rule 2.5 introduces the effect of temperature and size on copepod swimming velocity (adapted from Woods and Barkmann, 1994):

**Rule 2.5**

$$W_z = \left(0.3 + 0.7 \left(\frac{\text{Temp}}{T_{\text{ref}}}\right)\right) \min\left(\left(\frac{S}{S_{\text{max}}}\right), 1\right)$$

where:

- $W_z$  = [dimensionless] effect of T and size on swimming velocity
- Temp = ambient temperature [°C]
- $T_{\text{ref}}$  = 10 [°C] reference temperature
- S = surface area of individual [cm<sup>2</sup>]
- $S_{\text{max}}$  =  $1.3 \times 10^{-3}$  [cm<sup>2</sup>] maximum surface area of an adult copepod



### 3. Diel migration

During the hours of day light copepods keep at depth with relatively low irradiance to reduce the risk of being eaten. This depth is referred to as the target Isolume,  $I_t$  (Woods and Barkmann, 1994). If copepods are starving, they pursue a brighter isolume, trading a higher risk of being eaten for rate of feeding in shallow waters when diatoms are more abundant.

Rule 2.6 defines the size specific target isolume:

**Rule 2.6**

$$I_t = ((2 - Gut_f) \left( \min\left(\frac{S_{max}}{S}, 1\right) \right) I_{ref})$$

where:

- $I_t$  = size specific target isolume [ $Wm^{-2}$ ]  
 = 1 - 2 for adult copepods [ $Wm^{-2}$ ]  
 = 77.5 - 145.0 for nauplii [ $Wm^{-2}$ ]
- $I_{ref}$  = 1 [ $Wm^{-2}$ ] reference target isolume
- $Gut_f$  = gut fullness index,  
 = 0 if starved  
 = 1 if satiated
- $S$  = surface area of individual [ $cm^2$ ]
- $S_{max}$  =  $1.3 \times 10^{-3}$  [ $cm^2$ ] maximum surface area of an adult copepod

Rule 2.7 defines the index for speed and direction of the migration for chasing the target isolume:

**Rule 2.7**

$$kd_{calc} = (0.4 (Vis_{irrad} - I_t))$$

where:

- $kd_{calc}$  = target isolume index [dimensionless].  $-1 \leq kd_{calc} \leq 1$  the value gives the percentage of the maximum speed, the sign gives the direction of migration (negative upwards migration, positive downwards)
- $I_t$  = size specific target isolume [ $Wm^{-2}$ ]
- $Vis_{irrad}$  = ambient irradiance [ $Wm^{-2}$ ]

Rule 2.8 defines the direction and speed of migration  $k_{v\_day}$ :

**Rule 2.8**

$$k_{v\_day} = (\text{if } (kd_{calc} < -1) \text{ then } -1 \text{ else } (\text{if } (kd_{calc} \geq 1) \text{ then } 1 \text{ else } kd_{calc}))$$

where:

- $k_{v\_day}$  = direction and speed of migration during daytime [dimensionless]  
 $-1 \leq k_{v\_day} \leq 1$  (1 = maximum speed, the sign gives the direction of migration (negative upward, positive downward migration)
- $kd_{calc}$  = target isolume index [dimensionless] see rule 2.7

## From the literature on diel migration

The LERM rule for diel migration follows Woods & Barkmann (1994) for the WB model (Woods, 2005). The choice of target isolume determines the balance of risk between dying of starvation or being eaten. The parameterisation used in the WB and LERM models was established by optimisation experiments.

The copepod descends in the forenoon and ascends in the afternoon in pursuit a target isolume, the value of which is designated to reduce significantly the risk of the copepod being seen by a visual predator (squid in LERM).

The target isolume is therefore a function of the copepod's size (cross section area) and the ambient visible irradiance (PAR, 400-700nm) at its depth. It is a function of how hungry the copepod is, as measured by an index of gut fullness which ranges from 0 to 1. If the copepod is hungry, the copepod pursues a brighter target isolume, which starts to descend later in the forenoon, allowing the copepod more time to feed in shallow water.

---

### *Parameters values in the literature*

$S_{\max} = 1.3 \cdot 10^{-3} \text{ [cm}^2\text{]}$  surface area of an adult copepod  
Estimated from Caparroy and Carlotti (1996)

#### 4. Foraging

At night copepods migrate upwards to feed. As they swim they pass layers where the diatom concentration exceeds the threshold for grazing. This may be in the mixed layer or in the seasonal thermocline, in the deep chlorophyll maximum. Their ingestion rate in each layer is a function of the time spent in that layer and of the concentration of prey encountered (Woods and Barkmann, 1994). If the ambient concentration of the encountered prey decreases the copepods reverse their direction of swimming to optimise their feeding (Woods and Barkmann, 1994).

Rule 2.9 Computes the phytoplankton encountered in current timestep as copepod migrated:

*Rule 2.9*

$$D_{local} = \text{varietysum} (P)$$

*where:*

$D_{local}$  = [ind m<sup>-3</sup>] number of phytoplankters encountered during migration in the current timestep.

$\text{varietysum} (P)$  = [ind m<sup>-3</sup>] sum of prey encountered in present timestep  
varietysum is a VEW function (see Handbook VEW 3.3)

Rule 2.10 computes effect of satiation on the migration for foraging:

*Rule 2.10*

$$K_{n_{calc2}} = (0.4 (2 - Gut_f))$$

*where:*

$-0.4 \leq K_{n_{calc2}} \leq 0.8$  depending on how full is the gut [dimensionless]

$Gut_f$ , = satiation index  
= 0 if starved  
= 1 if satiated

Rule 2.11 computes the direction of migration during nocturnal foraging:

*Rule 2.11*

$$k_{v\_night} = (\text{if } (z > MLDepth) \text{ then } (\text{if } (z < 250) \text{ then } (\text{if } (D_{local} < D_{local\_previous}) \text{ then } - ((Direction[1] K_{n_{calc2}})) \text{ else } (Direction[1] K_{n_{calc2}})) - 1) \text{ else } 0.0)$$

*Where:*

$k_{v\_night}$  = percentage of maximum speed used for movement

$Direction[1]$  = direction in previous timestep,  
Direction[1] < 0 upward, Direction[1] > 0 downwards

$D_{local}$  = [ind m<sup>-3</sup>] food concentration encountered in current timestep

$D_{local\_previous}$  = [ind m<sup>-3</sup>] food concentration encountered in previous timestep

$-0.4 \leq K_{n_{calc2}} \leq 0.8$  depending on how full is the gut [dimensionless]

$MLDepth$  = Mixing Layer Depth [m]

$z$  = depth [m]

Rule 2.12 computes the direction of swimming at night:

<i>Rule 2.12</i>	
	Direction = (if ( $k_{\text{vnight}} > 0.0$ ) then 1 else -1)
Where:	
$k_{\text{v\_night}}$	= direction of migration during night-time [dimensionless]
Direction	= swimming direction in current timestep (downward) $0 < \text{Direction} < 0$ (upward),

Rule 2.13 records the prey concentration at the end of the current timestep:

<i>Rule 2.13</i>	
	$D_{\text{local}}_{\text{previous}} = D_{\text{local}}$
Where:	
$D_{\text{local}}_{\text{previous}}$	= food concentration in previous timestep [ $\text{ind m}^{-3}$ ]
$D_{\text{local}}$	= food concentration in current timestep [ $\text{ind m}^{-3}$ ]

---

### From the literature on foraging

At night copepods migrate to the surface to feed. As they swim upwards, they pass through a number of layers with varying concentration of prey. Their ingestion rate in each layer is a function of the time spent in that layer and of the concentration of prey encountered (Woods and Barkmann, 1994). If the concentration of encountered prey decreases as the copepods swim, they reverse the direction of swimming to optimise their feeding.

## 5. Swimming direction

Rule 2.14 computes the direction of migration and the percentage of maximum velocity:

**Rule 2.14**

$$k_v = (\text{if } (\text{visIrradAt}(0.0) > 0) \text{ then } k_{v\_day} \text{ else } k_{v\_night})$$

Where:

- $k_v$  = direction of swimming and speed of migration [dimensionless]
- $k_{v\_day}$  = direction and speed of migration in daytime [dimensionless]  
 $-1 \leq k_{v\_day} \leq 1$ , 1 = maximum speed, ( $k_{v\_day} < 0$  upward migration,  
 $k_{v\_day} > 0$  downward migration)
- $k_{v\_night}$  = as above for night-time [dimensionless]
- $\text{visIrradAt}(0)$  = Irradiance at surface [ $\text{Wm}^{-2}$ ]

## **6. Migration during diapause**

Rule 2.15 defines the vertical displacement during diapause:

*Rule 2.15*

$$V_m = 0$$

Where:

$V_m$  = vertical displacement [m]

### 7a. Migration out of diapause for OWA4

Rule 2.16a defines the vertical displacement during the ascent after diapause for the stage OWA4:

*Rule 2.16a*

$$V_m = - ((1 \text{ TimeStep}))$$

Where:

$V_m$  = vertical displacement [m]  
 $1$  = ascending speed from diapause [ $\text{m h}^{-1}$ ]  
 $\text{TimeStep} = 0.5$  [h]

Rule 2.17a defines end of ascent after diapause for stage OWA4:

*Rule 2.17a*

if  $((z \leq \text{Max}_{\text{MLD}}) \text{ or } (I_t \leq \text{Vis}_{\text{Irrad}}))$ , change (C4OW)

Where:

$z$  = depth [m]  
 $I_t$  = size specific target isolume [ $\text{Wm}^{-2}$ ]  
 $\text{Max}_{\text{MLD}}$  = annual maximum mixed layer depth [m]  
 $\text{Vis}_{\text{Irrad}}$  = ambient irradiance [ $\text{Wm}^{-2}$ ]

Normal motility resumes when either  $I_t$  or the  $\text{MLD}_{\text{max}}$  are reached (rule 2.18).

### **7b. Migration out of diapause for OWA5**

Rule 2.16b defines the vertical displacement speed during the ascent after diapause for stage OWA5:

*Rule 2.16b*

$$V_m = -(1 \text{ TimeStep})$$

Where:

$V_m$  = vertical displacement [m]  
 $1$  = ascending speed from diapause [ $\text{m h}^{-1}$ ]  
 $\text{TimeStep}$  = 0.5 [h]

Rule 2.17b defines end of ascent after diapause for stage OWA5:

*Rule 2.17b* When either  $I_t$  or the  $\text{MLD}_{\text{max}}$  is reached, motion goes back to normal.

if  $((z \leq \text{Max}_{\text{MLD}}) \text{ or } (I_t \leq \text{Vis}_{\text{Irrad}}))$ , change (C5)

Where:

$z$  = depth [m]  
 $I_t$  = size specific target isolume [ $\text{Wm}^{-2}$ ]  
 $\text{Max}_{\text{MLD}}$  = annual maximum mixed layer depth [m]  
 $\text{Vis}_{\text{Irrad}}$  = ambient irradiance [ $\text{Wm}^{-2}$ ]

Normal motility resumes when either  $I_t$  or the  $\text{MLD}_{\text{max}}$  are reached (rule 2.18).



## 8. Motility

Rule 2.18 computes the change in depth due to motion:

*Rule 2.18*

$$V_m = (k_v V_{\max} W_z \text{TimeStep})$$

where:

$V_m$	= depth displacement in a TimeStep [m]
$k_v$	= determines the direction of migration [dimensionless]
$V_{\max}$	= 45 [m h <sup>-1</sup> ] maximum swimming speed
${}_z W$	= effect of T and size on swimming velocity [dimensionless], see rule 2.5
TimeStep	= 0.5 [h]

---

### From the literature on motility

A copepod is assumed to be able to maintain neutral buoyancy with no energy expenditure. An adult copepod can swim vertically at a speed of up to 45 m/h when the temperature is 10°C (Woods and Barkmann, 1994).

The maximum vertical swimming speed is a function of the stage of development and of temperature (table 3, from Carlotti and Wolf, 1998).

---

### Parameters values in the literature

$$V_{\max} = 45 [\text{mh}^{-1}]$$

From Woods and Barkmann (1994)

## 9. Sinking of corpses

Gross and Raymont (1942) reported sinking speed of up to 2.4 mm/s (~ 100m/h) for female *Calanus finmarchicus*. LERM assumes a linear relationship surface area and sinking speed.

Rule 2.19 computes the change in depth of sinking corpses:

### Rule 2.19

$$V_m = (100 \frac{S}{S_{\max}} \text{ TimeStep})$$

where:

$V_m$  = vertical displacement in a timestep [m]

$S$  = surface area of individual [cm<sup>2</sup>]

$S_{\max}$  = 1.3 E-3 [cm<sup>2</sup>] maximum surface area of an adult copepod

TimeStep= 0.5 [h] t

100 = 100 [m h<sup>-1</sup>] maximum speed of sinking of dead adult copepods

---

### Parameters values in the literature

$S_{\max} = 1.3 \cdot 10^{-3}$  [cm<sup>2</sup>] surface area of an adult copepod,  
Estimated from Caparroy and Carlotti (1996)

## 10. Gut volume

Diagram of the processes involved in ingestion adapted from Caparroy and Carlotti (1996)

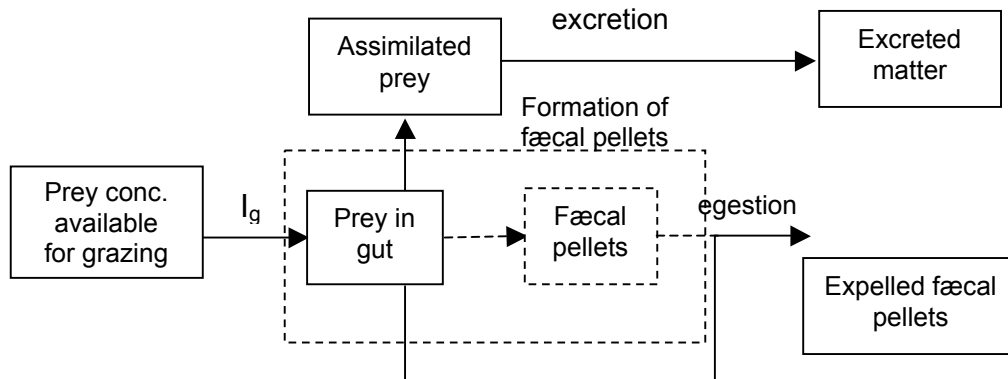

Rule 2.20 calculates the gut volume:

*Rule 2.20*

$$V_{\text{gut}} = (\text{vol}_{\text{gut}} L)$$

*where:*

- $V_{\text{gut}}$  = midgut volume [ $\text{cm}^3$ ]
- $\text{vol}_{\text{gut}}$  =  $1.5 \cdot 10^{-8}$  [ $\text{cm}^3 \mu\text{m}^{-1}$ ] gut volume parameter
- $L$  = Prosome length [ $\mu\text{m}$ ]

*vol\_gut and vol\_gut are equivalent notations*

Rule 2.21 to calculate the number of ingested cells during last timestep:

*Rule 2.21*

$$I_{\text{gCells}} = \text{varietysum} (\text{IngestedCells})$$

*where:*

- $I_{\text{gCells}}$  = number of ingested prey during last timestep [ind]
- varietysum = VEW function (see Handbook), add IngestedCells
- IngestedCells = number of species specific prey ingested in last timestep[ind]

*\*the units [ind] and [c] (cells) are equivalent*

Rule 2.22 records the number of timesteps since start of the day:

*Rule 2.22*

$$\text{Clock} = (\text{if} (\text{Clock} < 48) \text{ then} (\text{Clock} + 1.0) \text{ else } 0.0)$$

*where:*

- Clock = [dimensionless] number of timesteps since the start of the day

Rule 2.23 to calculate volume of prey ingested during current timestep:

**Rule 2.23**

$$\text{Prey}_{\text{vol}} = (\text{vPrey})\text{I}_{\text{gCells}}$$

*where:*

$\text{Prey}_{\text{vol}}$	= volume of prey ingested during current timestep [cm <sup>3</sup> ]
$\text{I}_{\text{gCells}}$	= number of ingested prey during last
$\text{vPrey}$	= 4.2 10 <sup>-9</sup> volume of a single prey cell [cm <sup>3</sup> ]

Rule 2.24 records the volume of prey ingested daily (diagnostic):

**Rule 2.24**

$$\text{Prey}_{\text{volDaily}} = (\text{if } (\text{Clock} < 48) \text{ then } (\text{Prey}_{\text{volDaily}} + \text{Prey}_{\text{vol}}) \text{ else } 0.0)$$

*where:*

$\text{Prey}_{\text{volDaily}}$	= volume of prey ingested daily [cm <sup>3</sup> ]
$\text{Prey}_{\text{vol}}$	= volume of prey ingested during last timestep [cm <sup>3</sup> ]

### **11. Respiration: basal metabolic cost**

Basal metabolism is the carbon consumed to maintain bodily functions; it depends on the size (i.e. proteins in their pools) and ambient temperature of the copepod.

Rule 2.25 defines the respiration rate for basal metabolism:

**Rule 2.25**

$$R_{\text{bas}} = (r_{\text{bas}} C_{\text{N\_Pool}}^{0.8} QR_{10}^{(\text{Temp} - T_{\text{ref}})/10})$$

*where:*

$R_{\text{bas}}$	= respiration for basal metabolism [mmolCarbon h <sup>-1</sup> ]
$r_{\text{bas}}$	= 4.17 10 <sup>-4</sup> [mmolC molC <sup>-1</sup> h <sup>-1</sup> ] basal metabolic coefficient
$QR_{10}$	= 3.4 [dimensionless] increase of basal metabolism for a 10°C increase above $T_{\text{ref}}$
Temp	= ambient temperature [°C]
$T_{\text{ref}}$	= 10 [°C] reference temperature

## 12. Respiration: Swimming cost

Rule 2.26 to compute the power expenditure of swimming copepod at velocity  $2 V_m/h$ ,  $P_{swim}$  :

**Rule 2.26**

$$P_{swim} = \frac{\left( \frac{k}{2} \frac{(1000 + \text{Density})}{1000} \right)^{(1-n)} \frac{L}{1000}^{-n} \left( \left| \frac{V_m}{\text{TimeStep}} \right| V_{mconv1} \right)^{(3-n)} mi^n S}{1 \times 10^7}$$

*where:*

- $P_{swim}$  = [J s<sup>-1</sup>] power expenditure of swimming copepod at velocity
- $V_m$  = vertical displacement in the timestep [m]
- Density = [kg m<sup>-3</sup>] seawater density
- k = 85.2 [dimensionless]coeff. empirical relationship drag coeff. & Reynolds number
- L = prosome length [μm]
- mi = 1.19 x 10<sup>-4</sup> [g cm<sup>-1</sup> s<sup>-1</sup>] seawater dynamic viscosity
- n = 0.8 coeff. empirical relationship drag coeff. & Reynolds number
- S = projected area of swimming copepod [cm<sup>2</sup>]
- $V_m$  = displacement in the timestep [m]
- $V_{mconv1}$  = 0.0278 converts swimming velocity from m/h to cm/s [cm s<sup>-1</sup>m h<sup>-1</sup>]
- TimeStep = 0.5 [h]

\* 10<sup>-7</sup> to match units: kg m<sup>2</sup> s<sup>-3</sup> to g cm<sup>2</sup> s<sup>-3</sup>; kg m<sup>2</sup> s<sup>-2</sup>s<sup>-1</sup>=g<sup>1-n</sup> cm<sup>3n-3</sup> cm<sup>-n</sup> cm<sup>3-n</sup> s<sup>n-3</sup>. g<sup>n</sup> cm<sup>-n</sup>s<sup>-n</sup>cm<sup>2</sup>

Rule 2.27 defines the catabolic cost of swimming activity:

**Rule 2.27**

$$Z_{swim} = \frac{P_{swim}}{E_{mech} E_m}$$

*where:*

- $Z_{swim}$  = [Js<sup>-1</sup>] catabolic cost of swimming activity at velocity  $2V_m/h$
- $E_{mech}$  = 0.3 [dimensionless] mechanical efficiency of swimming
- $E_m$  = 0.25 [dimensionless] muscular efficiency of copepod
- $P_{swim}$  = [Js<sup>-1</sup>] Power expenditure of swimming copepod at velocity  $2V_m/h$

Rule 2.28 to convert to oxygen consumption  $O_{\text{cons}}$  [ $\text{ml O}_2 \text{ h}^{-1}$ ]

**Rule 2.28**

$$O_{\text{cons}} = \frac{(Z_{\text{swim}} \cdot 3600)}{1000} \cdot \frac{C_{\text{cal}}}{1000}$$

*where:*

- $O_{\text{cons}}$  = oxygen consumption [ $\text{ml O}_2 \text{ h}^{-1}$ ]
- $Z_{\text{swim}}$  = catabolic cost of swimming activity at velocity  $2V_m/h$  [ $\text{Js}^{-1}$ ]
- $C_{\text{cal}}$  = 20.3 oxycaloric coefficient [ $\text{kJ l}^{-1}$ ]

Rule 2.29 to convert to oxygen consumption into C respiration:

**Rule 2.29**

$$R_{\text{swim}} = (O_{\text{cons}} \cdot \frac{12}{22.4} \cdot 1000 \cdot 8.33 \text{E-}5)$$

*where:*

- $R_{\text{swim}}$  = cost of swimming at velocity  $V_m$  [ $\text{mmolC h}^{-1}$ ]
- $O_{\text{cons}}$  = oxygen consumption [ $\text{ml h}^{-1}$ ]
- $12/22.4$  = 12 [g] weight of C in 22.4 [l] 1 mole of  $\text{CO}_2$
- $8.33 \text{ E-}5$  = conversion coefficient from gr C into mmol C

\* E-n equivalent to 10

### 13a. Preparing for diapause as OW4

Some of the copepods enter a pre-overwintering stage, POW4 or POW5, at the timestep when their protein pool reaches the threshold for metamorphosis to C4 or C5.

LERM follows Carlotti & Wolf (1998) in assuming that the probability is 30% for an individual entering the pre-overwintering stage before the 1st August and 50% afterward. During pre-overwintering all the assimilated food is allocated to lipid storage.

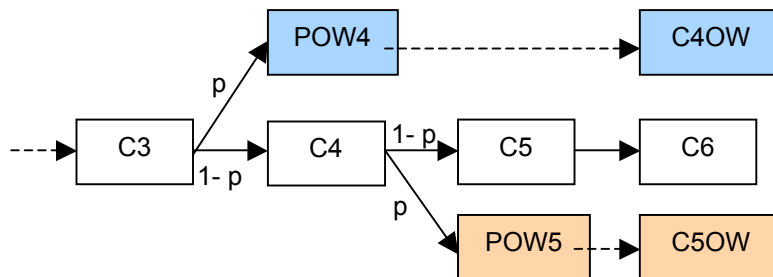

Fig. 2.5 Copepod pre-overwintering.  $p$  represents the probability of an individual entering pre-overwintering. Before the 1<sup>st</sup> Aug  $p = 0.3$ , after  $p = 0.5$ . Each colour represents an agent.

Rule 2.30a defines the condition for pre-overwintering from C3 into POW4

**Rule 2.30a**  
 if ( $C_{N\_Pool} \geq PreOW4$ ), pchange (POW4, (if ( $d_{year} \leq 210$ ) then 0.3 else 0.5)  
 where:  
 $C_{N\_Pool}$  = Protein pool [mmol C]  
 $d_{year}$  = day of the year since the 1<sup>st</sup> Jan (1<sup>st</sup> August)  
 $PreOW4$  =  $5.8 \text{ E-}4$  [mmol C] protein threshold for preoverwintering as POW4  
 $Pchange$  = VEW function (See Handbook VEW 3.3)  
 0.3 = 30% probability to enter pre-overwintering  
 0.5 = 50% probability to enter pre-overwintering  
 \*  $E-n$  equivalent to  $10^{-n}$

Rule 2.31a prevents copepod that were in diapause the winter before to re-enter it:

**Rule 2.31a**  
 if ( $C_{N\_Pool} \geq C4_{min}$ ), change (C4)  
 where:  
 $C_{N\_Pool}$  = Protein pool [mmol C]  
 $C4_{min}$  =  $5.8 \text{ E-}4$  [mmol C] protein threshold for metamorphosis to C4  
 \*  $E-n$  equivalent to  $10^{-n}$



### 13b. Preparing for diapause as OW5

Rule 2.30b defines condition for C4 to pre-overwintering to OW5

<b>Rule 2.30b</b>	
if ( $C_{N\_Pool} \geq \text{PreOW5}$ ), pchange (POW5, (if ( $d_{\text{year}} \leq 210$ ) then 0.3 else 0.5)	
where:	
$C_{N\_Pool}$	= Protein pool [mmol C]
$d_{\text{year}}$	= day of the year since the 1 <sup>st</sup> Jan (1 <sup>st</sup> August)
PreOW5	= 1.25 E-3 [mmol C] protein threshold for preoverwintering as POW5
Pchange	= VEW function (See Handbook VEW 3.3)
0.3	= 30% probability to enter pre-overwintering
0.5	= 50% probability to enter pre-overwintering
* E-n equivalent to $10^{-n}$	

Rule 2.31b prevents copepod that were in diapause the winter before to re-enter it:

<b>Rule 2.31b</b>	
if ( $C_{N\_Pool} \geq C5_{\text{min}}$ ), change (C5)	
where:	
$C_{N\_Pool}$	= protein pool [mmol C]
$C5_{\text{min}}$	= 1.25 E-3 [mmol C] protein threshold for metamorphosis to C5
* E-n equivalent to $10^{-n}$	

## 14. Preparing for diapause as C4OW

Rule 2.32 defines condition for pre-overwintering to C4OW

**Rule 2.32**

if ( $C_{N\_Pool} \geq C5_{mi}$ ), change (C5)

where:

$C_{N\_Pool}$  = protein pool [mmolCarbon]

$C5_{mi}$  = 1.25 E-3 [mmol C] protein threshold for entering stage C5

\* *E-n equivalent to  $10^{-n}$*

**15a. Starting diapause as POW4**

When the lipid reserve is full, copepods selected for diapause, are ready to swim toward the dormant phase (POW4). The descent to diapause starts when they are below the daily maximum depth of the turbocline. Then they swim down to a depth below 400m and over-winter there until mid March (day 95). During diapause, copepods do not swim or feed. Basal respiration is reduced to 20%; it is fueled by lipids or, if depleted, from protein.

Rule 2.33a defines the start of the diapause phase for both POW4:

**Rule 2.33a**

if ( $C_{NN\_Pool} \geq OW_{lipid}$ ), change (OWD4)

where:

$C_{NN\_Pool}$  = Lipid pool [mmol C]

$OW_{lipid}$  = 6.33 E-3 [mmol C] minimum lipid content for diapause

**15b. Starting diapause as POW5**

Rule 2.33b defines the start of the diapause phase for POW5:

**Rule 2.33b**

if ( $C_{NN\_Pool} \geq OW_{lipid}$ ), change (OWD5)

where:

$C_{NN\_Pool}$  = Lipid pool [mmol C]

$OW_{lipid}$  = 6.33 E-3 [mmol C] minimum lipid content for diapause

### 16a. Diapause OW4

During diapause respiration,  $R_{ow}$ , is sustained by lipids catabolism. If  $C_{NN}$  (lipid pool) is empty, then  $C_N$  (protein) are used (Fiksen and Carlotti, 1996).

Rule 2.34a defines respiration cost during diapause:

<i>Rule 2.34a</i>	
	$R_{ow} = (R_{bas} \text{ delta})$
<i>where:</i>	
$R_{ow}$	= respiration cost during diapause [mmolC h <sup>-1</sup> ]
$R_{bas}$	= respiration for basal metabolism [mmol C h <sup>-1</sup> ]
delta	= 0.2 [dimensionless] metabolic reduction during diapause

At the end of the diapause copepods migrate back to the surface where they resume feeding. Rule 2.35a defines the end of diapause of OW4:

<i>Rule 2.35b</i>	
	if ( $d_{year} = 75$ ), change(OWA4)
<i>where:</i>	
$d_{year}$	= days since 1 <sup>st</sup> January (15 <sup>th</sup> March)

### 16b. Diapause OW5

During diapause respiration,  $R_{ow}$ , is sustained by lipids catabolism. If  $C_{NN}$  (lipid pool) is empty, then  $C_N$  (protein) are used (Fiksen and Carlotti, 1996).

Rule 2.34b defines respiration cost during diapause:

<i>Rule 2.34b</i>	
	$(R_{ow} = R_{bas} \text{ delta})$
<i>where:</i>	
$R_{ow}$	= respiration cost during diapause [mmolC h <sup>-1</sup> ]
$R_{bas}$	= respiration for basal metabolism [mmol C h <sup>-1</sup> ]
delta	= 0.2 [dimensionless] metabolic reduction during diapause

At the end of the diapause copepods migrate back to the surface where they resume feeding. Rule 2.35a defines the end of diapause of OW5:

<i>Rule 2.35b</i>	
	if ( $d_{year} = 75$ ), change(OWA5)
<i>where:</i>	
$d_{year}$	= days since 1 <sup>st</sup> January (15 <sup>th</sup> March)

## **From the literature on diapause**

A fraction of copepods enters a pre-overwintering stage when their protein pool reaches the threshold for moulting to the next stage. During pre-overwintering the entire assimilated matter fills the lipid reserve to a maximum value, which in Carlotti and Wolf (1998) depends on stage. When the lipid reserve is full, copepods swim down to a depth below 400 m and over-winter there until mid-March. During diapause, copepods don't swim or feed. Basal metabolism is reduced to 20% and fueled preferentially by lipids or, if depleted, from the structural proteins. At the end of the diapause period copepods migrate back to the surface to feed.

## 17. Ingestion

Rule 2.36 calculate the maximum ingestion rate of prey:

<i>Rule 2.36</i>	
$Gut_{contPlusPrey} = (Gut_{content} + Prey_{vol})$	
<i>where:</i>	
$Gut_{contPlusPrey}$	= gut content prior to digestion [cm <sup>3</sup> ]
$Gut_{content}$	= volume of food in gut [cm <sup>3</sup> ]
$Prey_{vol}$	= volume of ingested prey during last timestep [cm <sup>3</sup> ]

Rule 2.37 defines the gut passage time

<i>rule 2.37</i>	
$Gut_{time} = (if (V_{gut} > 0.0) then \frac{(t_{min} \ t_{max})}{((\frac{Gut_{contPlusPrey}}{V_{gut}})(t_{max} - t_{min})) + t_{min}} else t_{max})$	
<i>where:</i>	
$Gut_{time}$	= gut passage time [h]
$t_{min}$	= 0.58 [h] minimum gut passage time (Caparroy&Carlotti, 1996)
$t_{max}$	= 1.08 [h] maximum gut passage time (Caparroy&Carlotti, 1996)
$Gut_{contPlusPrey}$	= gut content prior to digestion [cm <sup>3</sup> ]
$V_{gut}$	= gut volume [cm <sup>3</sup> ]

Rule 2.38 defines the gut clearance rate:

<i>rule 2.38</i>	
$Gut_{clear} = (if (Gut_{time} > 0) then \frac{Gut_{contPlusPrey}}{Gut_{time}} else 0)$	
<i>where:</i>	
$Gut_{clear}$	= gut clearance rate [cm <sup>3</sup> h <sup>-1</sup> ]
$Gut_{contPlusPrey}$	= gut content prior to digestion [cm <sup>3</sup> ]
$Gut_{time}$	= gut passage time [h]

Rule 2.39 defines the C assimilation efficiency (under the assumption that assimilation efficiency for nitrogen and carbon is the same):

<i>rule 2.39</i>	
$k_C = (1 - e^{-((b \ Gut_{time}))})$	
<i>where:</i>	
$k_C$	= carbon assimilation efficiency [dimensionless]
$b$	= 1.58 [h <sup>-1</sup> ] digestion rate of prey
$Gut_{time}$	= gut passage time [h]

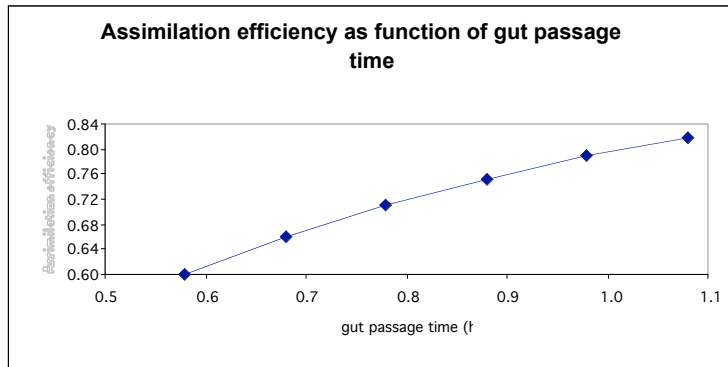

Fig. 2.2 Assimilation efficiency as function of gut passage time

Rule 2.40 defines the volume of undigested food:

*rule 2.40*

$$E = ((1-k_c) \text{Gut}_{\text{clear}})$$

where:

E = volume of food egestion rate [ $\text{cm}^3 \text{h}^{-1}$ ]  
 $k_c$  = carbon assimilation efficiency [dimensionless]  
 $\text{Gut}_{\text{clear}}$  = gut clearance rate [ $\text{cm}^3 \text{h}^{-1}$ ]

Rule 2.41 defines the volume of digested food:

*rule 2.41*

$$A = (k_c \text{Gut}_{\text{clear}})$$

where:

A = volume of food digestion rate [ $\text{cm}^3 \text{h}^{-1}$ ]  
 $k_c$  = carbon assimilation efficiency [dimensionless]  
 $\text{Gut}_{\text{clear}}$  = gut clearance rate [ $\text{cm}^3 \text{h}^{-1}$ ]

Rule 2.42 defines carbon assimilation rate:

*rule 2.42*

$$A_c = (k_c \text{Carbon}_{\text{ingested}})$$

where:

$A_c$  = carbon assimilation rate [ $\text{mmolCarbon h}^{-1}$ ]  
 $k_c$  = carbon assimilation efficiency [dimensionless]  
 $\text{Carbon}_{\text{ingested}}$  = carbon ingested during last timestep [ $\text{mmolC h}^{-1}$ ]

Rule 2.43 defines carbon egestion rate:

*rule 2.43*

$$E_c = ((1-k_c) \text{Carbon}_{\text{ingested}})$$

where:

$E_c$  = carbon egestion rate [ $\text{mmolCarbon h}^{-1}$ ]  
 $k_c$  = carbon assimilation efficiency [dimensionless]  
 $\text{Carbon}_{\text{ingested}}$  = carbon ingested during last timestep [ $\text{mmolCarbon}$ ]

Rule 2.44 calculates the maximum ingestion rate of prey:

**Rule 2.43**

$$\text{Gut}_{\text{contTemp}} = (\text{Gut}_{\text{contPlusPrey}} - ((A+E) \text{TimeStep}))$$

where:

- $\text{Gut}_{\text{contTemp}}$  = volume of prey in gut in current timestep [ $\text{cm}^3$ ]
- A = prey assimilation rate [ $\text{cm}^3 \text{h}^{-1}$ ]
- E = egestion rate [ $\text{cm}^3 \text{h}^{-1}$ ]
- $\text{Gut}_{\text{contPlusPrey}}$  = gut content prior to digestion [ $\text{cm}^3$ ]
- TimeStep = 0.5 [h]

Rule 2.45 defines the gut fullness in current timestep:

**Rule 2.45**

$$\text{Gut}_{\text{fTemp}} = \min(\text{if } ((\text{Gut}_{\text{contTemp}} = 0.0) \text{ and } (V_{\text{gut}} = 0.0)) \text{ then } 0.0 \text{ else } \frac{\text{Gut}_{\text{contTemp}}^2}{(0.67V_{\text{gut}})^2}, 1)$$

where:

- $\text{Gut}_{\text{fTemp}}$  = gut fullness in current timestep [dimensionless],  $0 \leq \text{Gut}_{\text{fTemp}} \leq 1$   
(0 = starve, 1 = gut full)
- $\text{Gut}_{\text{contTemp}}$  = volume of food in gut in current timestep [ $\text{cm}^3$ ]
- $V_{\text{gut}}$  = gut volume [ $\text{cm}^3$ ]

Rule 2.46 defines the gut fullness:

**Rule 2.46**

$$\text{Gut}_f = \text{Gut}_{\text{fTemp}}$$

where:

- $\text{Gut}_{\text{fTemp}}$  = gut fullness in current timestep [dimensionless],  $0 \leq \text{Gut}_{\text{fTemp}} \leq 1$   
(0 = starve, 1 = gut full)

Rule 2.47 defines the maximum ingestion rate:

**Rule 2.47**

$$I_{\text{max}} = \frac{((0.67 V_{\text{gut}} - \text{Gut}_{\text{contTemp}})}{(v\text{Prey } 1800)}$$

where:

- $I_{\text{max}}$  = maximum ingestion rate [ $\text{ind s}^{-1}$ ]
- $\text{Gut}_{\text{contTemp}}$  = volume of food in gut in current timestep [ $\text{cm}^3$ ]
- $v\text{Prey}$  =  $4.2 \times 10^{-9}$  [ $\text{cm}^3$ ] volume of a diatom gut volume



Rule 2.48 defines the stage specific ingestion rate:

**Rule 2.48**

$I_{gv} =$

$$\text{integrate}(\text{if}(\text{if}(P > P_{\min}) \text{ then } \min(\text{if}(V_{\text{gut}} > 0.0) \text{ then } (\text{PI} (L \cdot 2.9 \times 10^{-5})^2 \cdot 1 \cdot P \cdot 1 \times 10^{-6} \cdot (1 - \frac{(\text{Gut}_{\text{contTemp}})^2}{(0.67 V_{\text{gut}})^2}) \cdot (1 - e^{(-1.7 \times 10^{-8} P)})) \text{ else } I_{\max}), I_{\max}) \text{ else } 0))$$

=

$$\text{if}(z \neq z[1]) \text{ then } |z - z[1]| \text{ else } 1$$

Where

- $I_{gv}$  = stage specific ingestion rate [ind s<sup>-1</sup>]
- $\text{Gut}_{\text{contTemp}}$  = volume of prey in gut in current timestep [cm<sup>3</sup>]
- $I_{\max}$  = maximum ingestion rate [ind s<sup>-1</sup>]
- $L$  = carapace length [μm]
- $P$  = phytoplankton ambient concentration [ind cm<sup>-3</sup>]
- $P_{\min}$  = 10<sup>5</sup> minimum phytoplankton ambient concentration [ind cm<sup>-3</sup>]
- $\text{PI}$  = 3.14 (π)
- $V_{\text{gut}}$  = gut volume [cm<sup>3</sup>]
- $z$  = current depth [m]
- $z[1]$  = depth in previous timestep [m]

Rule 2.49 commands ingestion:

**Rule 2.49**

$$\text{ingest}(P, P_{\min}, I_{gv})$$

where:

- $\text{ingest}$  = VEW function (see VEW 3.3 Handbook)
- $I_{gv}$  = stage specific ingestion rate [ind s<sup>-1</sup>]
- $P$  = phytoplankton ambient concentration [ind cm<sup>-3</sup>]
- $P_{\min}$  = 10<sup>5</sup> minimum phytoplankton ambient concentration [ind cm<sup>-3</sup>]

### 18. N specific assimilation efficiency

Rule 2.50 defines the N specific assimilation efficiency as a function of gut passage:

**Rule 2.50**

$$k_N = (1 - e^{-((a \text{ Gut}_{\text{time}}))})$$

where:

- $k_N$  = nitrogen specific assimilation efficiency [dimensionless]
- $a$  = 1.584 [h<sup>-1</sup>] digestion rate of prey
- $\text{Gut}_{\text{time}}$  = gut passage time [h]

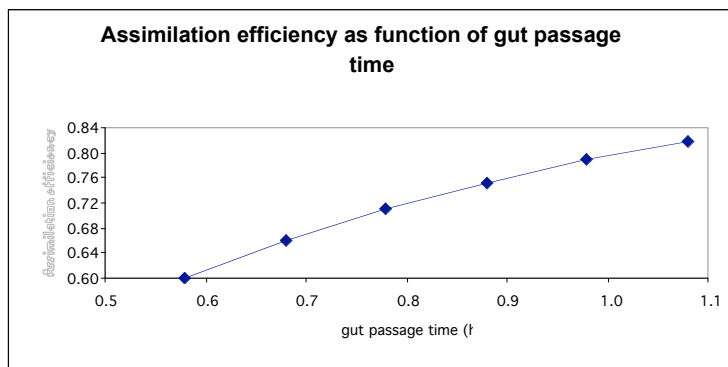

Fig.2.2. Assimilation efficiency as function of gut passage time

## 19. Egestion

The food ingested, but not assimilated, is egested as faecal pellets. Nitrogen that is not assimilated is egested in feces. Silicate is assumed to be completely removed before ingestion.

Rule 2.51 computes the nitrate egested in faecal pellets

<i>Rule 2.52</i>	
$E_N = ((1-k_N)(\text{Ammonium}_{\text{ingested}} + \text{Nitrate}_{\text{ingested}}))$	
<i>where:</i>	
$E_N$	= N egestion [mmol N]
$k_N$	= nitrogen assimilation efficiency
$\text{Ammonium}_{\text{ingested}}$	= rate of ammonium uptake
$\text{Nitrate}_{\text{ingested}}$	= rate of nitrate uptake [mmol N]

Rule 2.52

<i>Rule 2.52</i>	
$E_{Si} = \text{Silicate}_{\text{ingested}}$	
<i>where:</i>	
$E_{Si}$	= silicate added to faecal pellet [mmol Si]
$\text{Silicate}_{\text{ingested}}$	= rate of silicate uptake [mmol Si]

## 20. Fæcal pellet

Egestion occurs when a fæcal pellet reaches the threshold volume. Pellet volume is a function of prosome length.

Rule 2.53 defines the threshold volume of a fæcal pellets for egestion:

**Rule 2.53**

$$PV_{\text{egest}} = (1.4 \times 10^{-6} \frac{\text{Carbon}_{\text{pool}}}{G_{\text{max}}})$$

where:

- $PV_{\text{egest}}$  = threshold pellet volume for egestion [ $\text{cm}^3$ ]
- $\text{Carbon}_{\text{pool}}$  = Carbon pool [mmolC]
- $G_{\text{max}}$  = 8.33 E-3 [mmolC] maximum carbon pool of an individual
- $1.4 \times 10^6$  = [ $\text{cm}^3$ ] max volume of a fæcal pellet egested by an adult (Uye&Kamame, 1994)

Rule 2.54 calculates the volume a fæcal pellet has to reach before egestion:

**Rule 2.54**

$$PV = \text{if } ((PV + (E \text{ TimeStep}) \geq PV_{\text{egest}}) \text{ then } 0.0 \text{ else } (PV + (E \text{ TimeStep})))$$

where:

- $PV$  = pellet volume [ $\text{cm}^3$ ]
- $PV_{\text{egest}}$  = threshold pellet volume for egestion [ $\text{cm}^3$ ]
- $E$  = volume of food egestion rate [ $\text{cm}^3 \text{ h}^{-1}$ ]
- $\text{TimeStep}$  = 0.5 [h]

Rule 2.55 adds the egested ammonium in current timeStep to fæcal pellets:

**Rule 2.55**

$$P_{\text{amm}} = (\text{if } ((PV + (E \text{ TimeStep}) \geq PV_{\text{egest}}) \text{ then } 0 \text{ else } (P_{\text{amm}} + E_{\text{N}}))$$

where:

- $P_{\text{amm}}$  = Ammonium in fæcal pellet [mmolN]
- $PV$  = pellet volume [ $\text{cm}^3$ ]
- $PV_{\text{egest}}$  = threshold pellet volume for egestion [ $\text{cm}^3$ ]
- $E$  = volume of food egestion rate [ $\text{cm}^3 \text{ h}^{-1}$ ]
- $E_{\text{N}}$  = nitrogen egested in current timestep [mmolN]
- $\text{TimeStep}$  = 0.5 [h]

Rule 2.56 adds the egested carbon in the current timestep to the faecal pellets:

<b>Rule 2.56</b>	
$P_C = \text{if } ((PV + (E \text{ TimeStep}) \geq PV_{\text{egest}}) \text{ then } 0,0 \text{ else } (P_C + E_C))$	
<i>where:</i>	
$P_C$	= Carbon in faecal pellet [mmolCarbon]
$E$	= volume of food egestion rate [ $\text{cm}^3 \text{h}^{-1}$ ]
$E_C$	= carbon egested in current timestep [mmolCarbon]
$PV$	= pellet volume [ $\text{cm}^3$ ]
$PV_{\text{egest}}$	= threshold pellet volume for egestion [ $\text{cm}^3$ ]
$\text{TimeStep}$	= 0.5 [h]

Rule 2.57 stores the nitrogen egested at the time of faecal pellet egestion:

<b>Rule 2.57</b>	
$A_{\text{PelletLoss}} = \text{if } ((PV + (E \text{ TimeStep}) \geq PV_{\text{egest}}) \text{ then } (P_{\text{amm}} + E_N) \text{ else } 0.0)$	
<i>where:</i>	
$A_{\text{PelletLoss}}$	= nitrogen in faecal pellet [mmolN]
$PV$	= pellet volume [ $\text{cm}^3$ ]
$PV_{\text{egest}}$	= threshold pellet volume for egestion [ $\text{cm}^3$ ]
$E$	= volume of food egestion rate [ $\text{cm}^3 \text{h}^{-1}$ ]
$P_{\text{amm}}$	= Ammonium in faecal pellet [mmolN]
$E_N$	= nitrogen egested in current timestep [mmol N]
$\text{TimeStep}$	= 0.5 [h]

Rule 2.58 stores the egested nitrogen at the time of faecal pellet egestion:

<b>Rule 2.58</b>	
$\text{if } ((PV + (E \text{ TimeStep}) \geq PV_{\text{egest}}), \text{ create } (\text{Pellet}, 1)$	
	$\text{Ammonium}_{\text{Pool}} = ((P_{\text{amm}} + E_N))$
	$PV = (PV + (E \text{ TimeStep}))$
	$\text{Carbon}_{\text{Pool}} = (P_C + E_C)$
<i>where:</i>	
$PV$	= pellet volume [ $\text{cm}^3$ ]
$\text{Ammonium}_{\text{Pool}}$	= Ammonium pool of pellet [mmolN]
$\text{Carbon}_{\text{Pool}}$	= Carbon pool of pellet [mmolC]
$\text{create}$	= VEW function (see Handbook)
$E$	= volume of food egestion rate [ $\text{cm}^3 \text{h}^{-1}$ ]
$E_C$	= carbon egested in current timestep [mmolC]
$E_N$	= nitrogen egested in current timestep [mmolN]
$P_{\text{amm}}$	= Ammonium in faecal pellet [mmolN]
$P_C$	= Carbon in faecal pellet [mmolC]
$PV_{\text{egest}}$	= threshold pellet volume for egestion [ $\text{cm}^3$ ]
$\text{TimeStep}$	= 0.5 [h]

Rule 2.59:

**Rule 2.59**

release ( $E_{Si}$ , Silicate<sub>conc</sub>)

**where:**

- $E_{Si}$  = Silicate egested in current timestep [mmol Si]
- release = VEW function (see VW 3.3 Handbook)
- Silicate<sub>conc</sub> = ambient Silicate concentration [mmolSi m<sup>-3</sup>]

**From the literature on faecal pellet**

Unassimilated food is expelled as a faecal pellet (Woods and Barkmann, 1994). Egestion occurs when its volume reaches a threshold (Caparroy and Carlotti, 1996). Uye and Kaname (1994) proposed a relation between the volume of the faecal pellets (PV) and the prosome length (PL):  $\log PV [\mu\text{m}^3] = 2.474 \log PL [\text{mm}] + 5.226$ . The function of PV against PL is plotted below

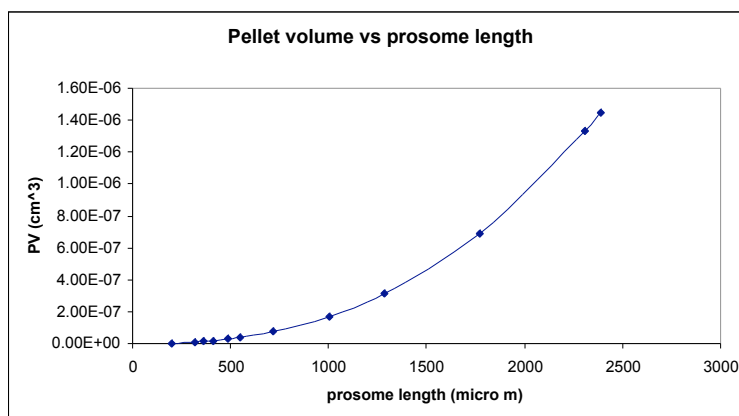

Fig.2.3. Pellet volume as function of copepod prosome length

## 21. Assimilation of ammonium

Rule 2.60 defines ammonium assimilation rate:

*rule 2.60*

$$A_{\text{Ammonium}} = (k_{\text{N}} \text{Ammonium}_{\text{ingested}})$$

*where:*

$A_{\text{Ammonium}}$  = ammonium assimilation rate [mmolN h<sup>-1</sup>]  
 $\text{Ammonium}_{\text{ingested}}$  = Ammonium ingested during last timestep [mmolN h<sup>-1</sup>]  
 $k_{\text{N}}$  = nitrogen assimilation efficiency [dimensionless]

Rule 2.57 defines nitrate assimilation rate:

*rule 2.57*

$$A_{\text{Nitrate}} = (k_{\text{N}} \text{Nitrate}_{\text{ingested}})$$

*where:*

$A_{\text{Nitrate}}$  = nitrate assimilation rate [mmolN h<sup>-1</sup>]  
 $k_{\text{N}}$  = nitrogen assimilation efficiency [dimensionless]  
 $\text{Nitrate}_{\text{ingested}}$  = Nitrate ingested during last timestep [mmolN h<sup>-1</sup>]

## 22. Respiration: specific dynamic action cost

SDA is the catabolic cost of growth. It is largely related to biosynthesis and transport, while the energy cost of feeding, gut activity, amino-acids oxidation and urea excretion are minor contributors (Kjørboe *et al.*, 1985).

Rule 2.62 defines the SDA respiration cost ( $r_{sda}$  from Kjørboe *et al.*, 1985):

*Rule 2.62*

$$R_{sda} = (r_{sda} A_c)$$

*where:*

$R_{sda}$  = Specific Dynamic Action rate [mmol C h<sup>-1</sup>]

$r_{sda}$  = 0.17 [dimensionless] SDA coefficient

$A_c$  = C assimilated in during last timestep [mmol C h<sup>-1</sup>]



## 23. Energetics

Rule 2.63 defines the growth rate:

<p><i>Rule 2.63</i></p> $\text{growth} = A_c$ <p>where:</p> <p>growth = net growth rate [mmolC h<sup>-1</sup>]  A<sub>c</sub> = rate of Carbon assimilated during last timestep [mmolC h<sup>-1</sup>]</p>
--

Rule 2.64 defines the respiration rate for activity metabolism of a copepod:

<p><i>Rule 2.64</i></p> $\text{respiration} = (R_{\text{bas}} + R_{\text{sda}} + R_{\text{swim}})$ <p>where:</p> <p>respiration = total respiration rate [mmolC h<sup>-1</sup>]  R<sub>bas</sub> = basal respiration [mmolC h<sup>-1</sup>]  R<sub>sda</sub> = SDA [mmolC h<sup>-1</sup>]  R<sub>swim</sub> = Respiration cost for swimming at speed 2V<sub>m</sub>/h [mmolC h<sup>-1</sup>]</p>
--

Rule 2.65 defines the respiration rate for activity metabolism of a copepod:

<p><i>Rule 2.65</i></p> $\text{Growth}_{\text{net}} = (\text{growth} - \text{respiration})$ <p>where:</p> <p>Growth<sub>net</sub> = net growth rate [mmolC h<sup>-1</sup>]  growth = C assimilated during last timestep [mmolC h<sup>-1</sup>]  respiration = total respiration rate [mmolC h<sup>-1</sup>]</p>
---

## 24. Energetics during diapause

Rule 2.67 defines the growth rate:

<p><i>Rule 2.67</i></p> $\text{growth} = A_c$ <p>where:</p> <p>growth = net growth rate [mmolC h<sup>-1</sup>]  <math>A_c</math> = rate of Carbon assimilated during last timestep [mmolC h<sup>-1</sup>]</p>
---

Rule 2.68 defines the respiration rate for activity metabolism of a copepod:

<p><i>Rule 2.68</i></p> $\text{respiration} = R_{ow}$ <p>where:</p> <p>respiration = total respiration rate [mmolC h<sup>-1</sup>]  <math>R_{ow}</math> = respiration during diapause [mmolC h<sup>-1</sup>]</p>
--

Rule 2.69 defines the respiration rate for activity metabolism of a copepod:

<p><i>Rule 2.69</i></p> $\text{Growth}_{net} = (\text{growth} - \text{respiration})$ <p>where:</p> <p><math>\text{Growth}_{net}</math> = net growth rate [mmolC h<sup>-1</sup>]  growth = C assimilated during last timestep [mmolC h<sup>-1</sup>]  respiration = total respiration rate [mmolC h<sup>-1</sup>]</p>
--

**25a. Start descent to diapause for OWD4**

Rule 2.70a computes vertical displacement during diapause descent:

*Rule 2.70a*

$$V_m = (1 \text{ TimeStep})$$

where:

$V_m$	= particle displacement during last timestep [m]
1	= 1 [m h <sup>-1</sup> ] sinking speed
TimeStep	= 0.5 [h]

Rule 2.71a:

*Rule 2.71a*

if ( $z \geq z_{\text{startOW}}$ ), change(OW4)

where:

$z$	= depth [m]
$z_{\text{startOW}}$	= 400 [m] minimum depth for starting diapause

**25b. Start descent to diapause for OWD5**

Rule 2.70b computes vertical displacement during diapause descent:

*Rule 2.70b*

$$V_m = (1 \text{ TimeStep})$$

where:

$V_m$	= particle displacement during last timestep [m]
1	= 1 [m h <sup>-1</sup> ] sinking speed
TimeStep	= 0.5 [h]

Rule 2.71b:

*Rule 2.71b*

if ( $z \geq z_{\text{startOW}}$ ), change(OW5)

where:

$z$	= depth [m]
$z_{\text{startOW}}$	= 400 [m] minimum depth for starting diapause

## 26. Become adult

Rule 2.72 changes copepod state to adult:

<i>Rule 2.72</i>	
	if ( $C_{N\_Pool} \geq G_{max}$ ), change(Adult)
<i>where:</i>	
$C_{N\_Pool}$	= protein pool [mmolC]
$G_{max}$	= 8.33E-3 [mmolC] maximum C content of an individual

## 27. Become mature

Rule 2.73 changes copepod state to mature:

<i>Rule 2.73</i>	
	$A_r = (A_r + TimeStep)$
<i>where:</i>	
$A_r$	= age since maturity [h]
TimeStep	= 0.5 [h]

Rule 2.74 changes copepod stage to mature:

<i>Rule 2.74</i>	
	if ( $(A_r = A_{rep})$ and ( $C_{N\_Pool} \geq G_{max}$ ), change(Mature)
<i>where:</i>	
$A_r$	= Age since maturity [h]
$A_{rep}$	= 480 [h] Age at fecundity
$C_{N\_Pool}$	= protein pool [mmol C]
$G_{max}$	= 8.33 E-3 [mmol C] maximum C content of an individual

## 28. Naupliar mortality counter

Rule 2.75:

<i>Rule 2.75</i>	
	$Nauplius_{counter} = (Nauplius_{counter} + TimeStep)$
<i>where:</i>	
$Nauplius_{counter}$	= time since birth [h]
TimeStep	= 0.5 [h]

## 29. Pellet sinking

The food ingested, but not assimilated, is egested as a faecal pellet.

Rule 2.76 computes the pellet sinking displacement according to Stoke's law:

**Rule 2.76**

$$SR_{\text{pellet}} = \frac{10^{[0.698 \log (PV \cdot 10E12) - 2.030]}}{48}$$

where:

SR <sub>pellet</sub>	= sinking displacement [m]
PV	= pellet volume [cm <sup>3</sup> ]
48	= number of timesteps in a day [h]
10	= pellet sinking speed [m h <sup>-1</sup> ]

Rule 2.78 computes the depth of a faecal pellet:

**Rule 2.78**

$$z = (\text{if } (z < \text{MLDepth}) \text{ then } (\text{rnd}(\text{MLDepth}) + \text{SR}_{\text{pellet}}) \text{ else } (z + \text{SR}_{\text{pellet}}))$$

where:

z	= depth [m]
SR <sub>pellet</sub>	= sinking displacement [m]
MLDepth	= mixed layer depth
rnd	= function of the VEW see Handbook range (0 – MLDepth)

### From the literature on pellet sinking

The pellet sinking rate is computed using the equation of Paffenhofer and Kwnoles (1979) obtained from Stoke's law:  $\text{Log SR [m d}^{-1}] = 0.698 \log PV [\mu\text{m}^3] - 2.030$ . The relation between the speed of pellet sinking and its volume is plotted below:

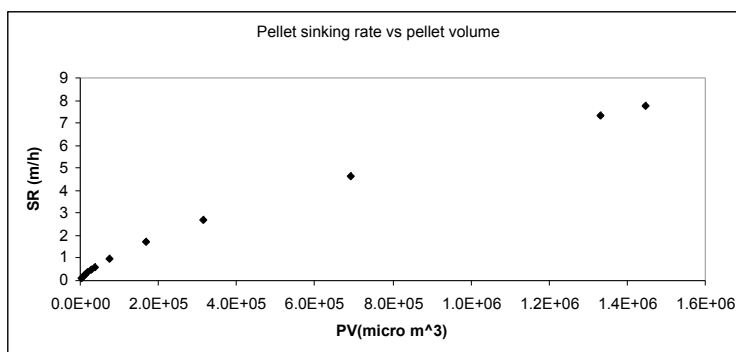

Fig. 2.6. Pellet sinking speed as function of its volume.

### 30a. Turn POW4 into C4OW

Rule 2.77a changes the state of POW4 into the stage C4OW to avoid that POW4 with lipid pool just below the overwintering treshold, migrate to diapause in late winter:

*Rule 2.77a*

if ( $d_{\text{year}} > 351$ ), change (C4OW)

where:

$d_{\text{year}}$  = days this year since 1<sup>st</sup> January

### 30b. Turn POW5 into C5

Rule 2.78b changes the state of POW5 to C5 to avoid that POW5 with lipid pool just below the overwintering treshold, migrate to diapause in late winter:

*Rule 2.78b*

if ( $d_{\text{year}} > 351$ ), change (C5)

where:

$d_{\text{year}}$  = days this year since 1<sup>st</sup> January

### 31. Update gut content

Rule 2.79 updates gut content to the value of the current timestep:

*Rule 2.79*

$Gut_{\text{content}} = Gut_{\text{contTemp}}$

where:

$Gut_{\text{content}}$  = volume of ingested prey [ $\text{cm}^3$ ]

$Gut_{\text{contTemp}}$  = volume of ingested prey in gut [ $\text{cm}^3$ ]

### 32. Update depth

Rule 2.79 defines the depth at the current timestep:

**Rule 2.79**

$$Z_{temp} = \max ((\text{if } (z \leq \text{MLDepth}) \text{ then } (\text{rnd}(\text{MLDepth}) + V_m) \text{ else } (z + V_m)), 0.0)$$

**where:**

$z$	= depth [m]
$Z_{temp}$	= current depth [m]
MLDepth	= Mixing Layer Depth [m]
rnd	= VEW function, it ranges from 0 to MLDepth (see VEW 3.3 Handbook)
$V_m$	= Vertical displacement during last timestep [m]

Rule 2.80: updates the copepod depth:

**Rule 2.80**

$$Z = Z_{temp}$$

**where:**

$z$	= depth [m]
$Z_{temp}$	= current depth [m]



### 33. Allocation of assimilated carbon

In LERM the assimilated carbon is allocated to storage (lipids) and growth (proteins) in proportions depending on the copepod development stage, and to the production of the carapace (chitin) in a fixed proportion (5% from Vidal, 1980)

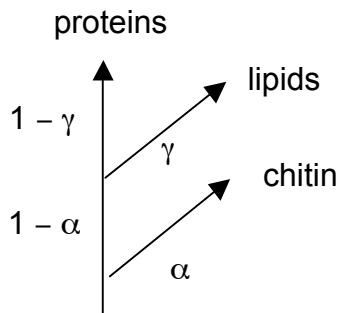

Fig. 2.4 Dynamic allocation of assimilated C.  $\alpha$  is the fraction allocated to carapace,  $\gamma$  is the fraction allocated to lipid reserve,  $1-\gamma$  the fraction allocated to proteins.

Young copepods (Nauplius to C3) allocate the same amount of assimilated carbon to lipids and proteins. Older copepods (C4 to Senescent) allocate more to lipids (Fiksen and Carlotti, 1998). Copepods preparing for the diapause (POW4, POW5, OWD4 and OWD5) allocate assimilated carbon exclusively to lipids (Carlotti and Wolf, 1998).

The amount of lipids stored in the fat sac is function of the structural body mass. When a copepod reaches the threshold for reproduction, its structural mass does not change and the assimilated matter is allocated to storage (Fiksen and Carlotti, 1996).

The specific rules to allocate the assimilated carbon appearing in the VEW are in the following pages.

This general rule that computes the assimilated carbon:

<b>Rule</b>	
	$C_{pool} = \alpha C + \gamma C + (1 - \gamma)C$
	$\alpha C = C_{shell}$
	$\gamma C = C_{NN}$
	$(1 - \gamma) C = C_N$
<b>where:</b>	
$\alpha$	= C allocated to carapace = 0.5 for all stages
$\gamma$	= C allocated to storage (lipids)
$\gamma$	= 0.5 for stages N3 to C3
$\gamma$	= 0.7 for all other stages
$\gamma$	= 1 for pre-overwintering stages (POW4, POW5, OWD4, OWD5)
$\gamma$	= 1 for mature stage (Ma)
$C_{shell}$	= chitin (carbon in carapace) [mmol C]
$C_{NN}$	= proteins (nitrogenous carbon pool) [mmol C]
$C_N$	= proteins (nitrogenous carbon pool) [mmol C]

## From the literature on assimilated carbon

The amount of lipids stored in the fat sac is function of the structural body mass. During copepodite stages (structural weight  $8.33 \cdot 10^{-3}$  mmol C) assimilated matter can be allocated to storage (lipids) or growth (proteins).

A fixed proportion (5%) of assimilated carbon is allocated to the production of carapace (Vidal, 1980). The rest is allocated to storage (lipids) and growth (proteins) in proportions depending on the copepod development stage.

Young copepods (Nauplius to C3) allocate it equally to lipids and proteins. Older copepods (C4 to Senescent) allocate it more to lipids ( $\gamma = 0.7$  from Fiksen and Carlotti, 1998) Copepods preparing to overwinter (POW4, POW5, OWD4 and OWD5) allocate assimilated carbon exclusively to lipids (Carlotti and Wolf, 1998). When a copepod reaches the threshold for reproduction, its structural mass does not change and the assimilated matter is allocated storage (Fiksen and Carlotti, 1996).

### *Parameters values in the literature*

- $\alpha$  = C allocated to carapace = 0.5 for all stages  
From Vidal, 1980
- $\gamma$  = 0.5 for stages N3 to C3  
Fiksen and Carlotti, 1998
- $\gamma$  = 0.7 for all other stages  
Fiksen and Carlotti, 1998
- $\gamma$  = 1 for pre-overwintering (POW4, POW5, OWD4, OWD5, Ma) and mature stages (Ma)  
From Carlotti and Wolf, 1998

### **33a. Allocation of carbon to storage 1**

Rule 2.81a

<i>Rule 2.81a</i>	
	gamma = 0.5
<i>where:</i>	
gamma	= fraction of assimilated carbon [dimensionless]

### **33b. Allocation of carbon to storage 2**

Rule 2.81b

<i>Rule 2.81b</i>	
	gamma = 0.7
<i>where:</i>	
gamma	= fraction of assimilated carbon [dimensionless]

### **33c. Allocation of carbon storage 3**

Rule 2.81c

<i>Rule 2.81c</i>	
	gamma = 1.0
<i>where:</i>	
gamma	= fraction of assimilated carbon [dimensionless]

### **33d. Allocation of carbon to carapace**

Rule 2.81d

<i>Rule 2.81d</i>	
	alpha = (if (Growth <sub>net</sub> > 0.0)then 0.05 else 0.0)
<i>where:</i>	
alpha	= fraction of assimilated carbon allocated to carapace building [dimensionless]
Growth <sub>net</sub>	= net growth rate [mmolc]
0.05	= maximum percentage of carbon allocated to carapace

### 34. Lipid pool

Rule 2.82 updates the lipid pool:

**Rule 2.82**

$$C_{NN\_Pool} = \text{(if (Growth}_{net} \geq 0.0) \text{then } (C_{NN\_Pool} + (\text{gamma}(1-\text{alpha})\text{Growth}_{net}\text{TimeStep})) \text{ else (if } C_{NN\_Pool} \geq (|\text{Growth}_{net}|\text{TimeStep})) \text{then } (C_{NN\_Pool} + (\text{Growth}_{net}\text{TimeStep})) \text{ else } C_{NN\_Pool})$$

*where:*

$C_{NN\_Pool}$  = lipid pool [mmol C]  
 $\alpha$  = fraction of assimilated carbon allocated to carapace building [dimensionless]  
 $\gamma$  = fraction of carbon allocated to storage [dimensionless]  
 $\text{Growth}_{net}$  = net growth rate [mmol C]  
 $\text{TimeStep}$  = 0.5 [h]

Rule 2.83 updates the nitrogen to carbon ratio:

**Rule 2.83**

$$Q_N = \frac{(\text{Ammonium}_{Pool} + (A_{\text{Ammonium}} \text{TimeStep}))}{(\text{Carbon}_{Pool} + (\text{Growth}_{net} \text{TimeStep}))}$$

*where:*

$A_{\text{Ammonium}}$  = ammonium assimilation rate [mmol N h<sup>-1</sup>]  
 $\text{Growth}_{net}$  = net growth rate [mmol C]  
 $\text{TimeStep}$  = 0.5 [h]

Rule 2.84 defines  $N_{\text{prot}_{excess}}$ , nitrogen above the max nitrogen to carbon ratio:

**Rule 2.84**

$$N_{\text{prot}_{excess}} = \text{(if } ((C_{NN\_Pool} \geq (|\text{Growth}_{net}|\text{TimeStep})) \text{ and } (Q_N > Q_{Nmax})) \text{then } ((\text{Carbon}_{Pool} + (\text{Growth}_{net}\text{TimeStep})) (Q_N > Q_{Nmax})) \text{ else } 0.0)$$

*where:*

$Q_{Nmax}$  = 0.23 max N:C [[mmolN mmolC<sup>-1</sup>]  
 $\text{Growth}_{net}$  = net growth rate [mmol C]  
 $\text{TimeStep}$  = 0.5 [h]

### 35. Protein pool

2.85 updates the protein pool:

**Rule 2.85**

$$C_{N\_Pool} = (\text{if } (Growth_{net} \geq 0.0) \text{ then } (C_{N\_Pool} + ((1 - \gamma)(1 - \alpha) Growth_{net} TimeStep)) \text{ else } (\text{if } C_{NN\_Pool} \geq (|Growth_{net}| TimeStep) \text{ then } C_{N\_Pool} \text{ else } (C_{N\_Pool} + (Growth_{net} TimeStep))))$$

*where:*

alpha = fraction of assimilated carbon allocated to carapace building [dimensionless]  
 gamma = fraction of assimilated carbon allocated to storage  
 Growth<sub>net</sub> = net growth rate [mmol C]  
 TimeStep = 0.5 [h]

Rule 2.86 defines C<sub>prot</sub>, nitrogen excreted due to protein catabolism:

**Rule 2.86**

$$C_{prot} = (\text{if } ((Growth_{net} < 0.0) \text{ and } (C_{NN\_Pool} < |Growth_{net}| TimeStep)) \text{ then } (Q_{nProt} | Growth_{net} | TimeStep) \text{ else } 0.0)$$

*where:*

C<sub>prot</sub> = nitrogen excreted for protein catabolism [mmol N]  
 Growth<sub>net</sub> = net growth rate [mmol C]  
 Q<sub>nProt</sub> = 0.27 fixed N:C ratio in protein [mmolN mmolC<sup>-1</sup>]

### 36. Carapace C pool

2.87 updates the carbon pool in carapace:

**Rule 2.83**

$$C_{\text{shell}} = (C_{\text{shell}} + (\text{if } (\text{Growth}_{\text{net}} > 0.0) \text{ then } (\text{Growth}_{\text{net}} \alpha \text{ TimeStep}) \text{ else } 0.0))$$

where:

alpha = fraction of assimilated carbon allocated to carapace building [dimensionless]

Growth<sub>net</sub> = net growth rate [mmol C]

### 37. Total carbon

2.88 updates the total carbon pool

**Rule 2.88**

$$\text{Carbon}_{\text{pool}} = (C_{\text{N\_Pool}} + C_{\text{NN\_Pool}} + C_{\text{N\_shell}})$$

where:

C<sub>N\_Pool</sub> = protein pool [mmol C]

C<sub>NN\_Pool</sub> = lipid pool [mmol C]

C<sub>N\_shell</sub> = carbon in carapace [mmol C]

### 38. Ammonium pool

2.89 updates the ammonium pool

**Rule 2.89**

$$\text{Ammonium}_{\text{pool}} = (\text{Ammonium}_{\text{pool}} + \text{Ammonium}_{\text{ingested}} + A_{\text{Nitrate}}) - A_{\text{PelletLoss}} + N_{\text{prot}_{\text{excess}}} + C_{\text{prot}}$$

where:

Ammonium<sub>pool</sub> = ammonium (total nitrogen) pool [mmol N]

Ammonium<sub>ingested</sub> = ammonium ingested [mmol N]

A<sub>Nitrate</sub> = nitrate assimilation [mmol N]

A<sub>PelletLoss</sub> = loss of ammonium in faecal pellets [mmol N]

N<sub>prot<sub>excess</sub></sub> = nitrogen excreted over N:C ratio [mmol N]

C<sub>prot</sub> = nitrogen excreted for protein catabolism [mmol N]

### **39. Nitrate pool**

Rule 2.90 sets nitrate pool to zero.

*Rule 2.90*

$$\text{Nitrate}_{\text{pool}} = 0.0$$

---

### **40. Total nitrogen**

Rule 2.91 updates the nitrogen pool:

*Rule 2.91*

$$\text{Nitrogen}_{\text{pool}} = (\text{Ammonium}_{\text{pool}} + \text{Nitrate}_{\text{pool}})$$

Rule 2.92 defines the ratio ammonium to total nitrogen:

*Rule 2.92*

$$Q_{AN} = \frac{\text{Ammonium}_{\text{pool}}}{(\text{Ammonium}_{\text{pool}} + \text{Nitrate}_{\text{pool}})}$$

---

### **41. Silicate pool**

Rule 2.93 defines the silicate ingested as immediately released into the water (see rules 2.52 and 2.59):

*Rule 2.93*

$$\text{Silicate}_{\text{pool}} = 0.0$$

## 42. Reproduction

A copepod enters the mature stage when the internal proteins  $C_N$  reach the threshold for reproduction ( $8.33 \times 10^{-3}$  mmol C). For 20 days after reaching maturity the copepod uses stored carbon to produce eggs.

A copepod is assumed to be able to produce a maximum of 800 nauplii (Carlotti and Wolf, 1998). Each nauplius has a set initial carbon pool ( $G_{min}$ ), which is composed in equal parts by lipids and proteins. The ratio N:C in nauplius is the same as in the parent.

LERM assumes that assumed that 90% of the offspring die in the first timestep after hatching (Woods & Barkmann, 1994).

Rule 2.94 defines the time since maturity:

*Rule 2.90*

$$A_r = (A_r + \text{TimeStep})$$

*where:*

$A_r$  = time since maturity was reached [h]  
 $\text{TimeStep}$  = 0.5 [h]

Rule 2.95 flags reproduction:

*Rule 2.95*

if ( $A_r \geq A_{rep}$ ) and ( $C_{N\_Pool} \geq G_{max}$ ), Reproduce = 1

*where:*

$A_r$  = time since maturity was reached [h]  
 $A_{rep}$  = 480 [h]  
 $C_{N\_Pool}$  = protein pool [mmolC]  
 $G_{max}$  =  $8.33 \times 10^{-3}$  protein threshold for reproduction [mmol C]  
 Reproduce = VEW function (see VEW 3.3 Handbook)

Rule 2.96 calculates the number of offspring:

*Rule 2.96*

Nauplii =

$$(\text{if } (\text{Reproduce}=1) \text{ then } (\text{if } C_{NN\_Pool} > (C_{N\_Pool} - G_{max})) \text{ then } (\frac{C_{N\_Pool} - G_{max}}{G_{min}} - 2) \text{ else } (2 \frac{C_{NN\_Pool}}{G_{min}})) \text{ else } 0.0)$$

*where:*

$C_{N\_Pool}$  = protein pool [mmolC]  
 $C_{NN\_Pool}$  = lipid pool [mmolC]  
 $G_{max}$  =  $8.33 \times 10^{-3}$  protein threshold for reproduction [mmol C]



Rule 2.97

**Rule 2.97**

if (Reproduce=1), create (Nauplius, min (Nauplii, 800))

$$\begin{aligned} \text{Carbon}_{\text{Pool}} &= G_{\text{Min}} \\ A_r &= 0.0 \\ \text{Gut}_{\text{content}} &= 0.0 \\ \text{Ammonium}_{\text{pool}} &= (G_{\text{min}} Q_N) \\ \text{Nitrate}_{\text{pool}} &= (G_{\text{min}} Q_N(1 - Q_{AN})) \\ C_{N\_Pool} &= \frac{(G_{\text{min}} (1-0.05))}{2} \\ C_{NN\_Pool} &= \frac{((1-0.05) G_{\text{min}})}{2} \\ C_{N\_Shell} &= (G_{\text{min}}0.05) \\ C_{pmaxl} &= \frac{(G_{\text{min}}(1-0.05))}{2} \\ V_{\text{gut}} &= 4 \times 10^{-6} \end{aligned}$$

where:

- $C_{N\_Pool}$  = protein pool [mmolC]
- $C_{NN\_Pool}$  = lipid pool [mmolC]
- $G_{\text{max}}$  = protein threshold for reproduction [mmol C]

Rule 2.98 defines that after reproduction the copepod become senescent:

**Rule 2.98**

if (Reproduce=1), change (Senescent)

---

**From the literature on reproduction**

Once copepods reach the adult stage, they enter a 20 days period of egg production (Woods and Barkmann, 1994). The number of eggs produced depends on how well they feed during that period. After 20 days, copepods are ready to lay eggs. If the lipid pool is larger than the ingested matter during this period, then egg production is limited by proteins, otherwise it is limited by lipids (Carlotti and Wolf, 1998).

The egg stage is not modelled explicitly, but an instantaneous mortality of 90% is assumed (Woods and Barkmann, 1994).

### 43. Eggs production

Rule 2.98 updates the parent's lipid pool:

<b>Rule 2.98</b>	
$C_{NN\_pool} = (\text{if } (\text{Reproduce}=1) \text{ then } (C_{NN\_pool} - \min((C_{N\_pool} - G_{max}), C_{NN\_pool})) \text{ else } C_{NN\_pool})$	
where:	
$C_{N\_Pool}$	= protein pool [mmolC]
$C_{NN\_Pool}$	= lipid pool [mmolC]
$G_{max}$	= $8.33 \times 10^{-3}$ protein threshold for reproduction [mmol C]

Rule 2.99 updates the parent's protein pool:

<b>Rule 2.99</b>	
$C_{N\_pool} = (\text{if } (\text{Reproduce}=1) \text{ then } (C_{N\_pool} - \min((C_{N\_pool} - G_{max}), C_{NN\_pool})) \text{ else } C_{N\_pool})$	
where:	
$C_{N\_Pool}$	= protein pool [mmolC]
$C_{NN\_Pool}$	= lipid pool [mmolC]
$G_{max}$	= $8.33 \times 10^{-3}$ protein threshold for reproduction [mmol C]

Rule 2.100 updates the parent's ammonium pool:

<b>Rule 2.100</b>	
$\text{Ammonium}_{Pool} = (\text{if } (\text{Reproduce}=1) \text{ then } ((\text{Ammonium}_{Pool} - ((Q_N G_{min} \min(\text{Nauplii}, 800)) + N_{\text{Prot}_{excess}} + C_{\text{prot}} + A_{\text{PelletLoss}})) + \text{Ammonium}_{\text{Ingested}} + A_{\text{Nitrate}}) \text{ else } \text{Ammonium}_{Pool})$	
where:	
$\text{Ammonium}_{\text{ingested}}$	= ammonium ingested
$\text{Ammonium}_{\text{pool}}$	= ammonium (total nitrogen) pool [mmol N]
$A_{\text{Nitrate}}$	= nitrate assimilation rate [mmol N h <sup>-1</sup> ]
$A_{\text{PelletLoss}}$	= loss of ammonium in faecal pellets [mmol N]
$C_{\text{prot}}$	= nitrogen excreted for protein catabolism [mmol N]
$G_{min}$	= $1 \times 10^{-5}$ weight of newly born nauplius [mmol C]
$N_{\text{prot}_{excess}}$	= nitrogen excreted over N:C ratio [mmol N]
$Q_N$	= nitrogen to carbon ratio [mmolN mmolC <sup>-1</sup> ]

#### 44. Naupliar mortality

Rule 2.101 defines the percentage of offspring mortality at 90%:

<i>Rule 2.101</i>	
	if ( $\text{Nauplius}_{\text{counter}} \geq 1$ ), pchange (Dead, $N_{\text{mp}}$ )
<i>where:</i>	
$N_{\text{mp}}$	= 0.9 chances of mortality for a nauplius
pchange	= VEW function (see VEW 3.3 Handbook)

Rule 2.102 defines the chance of survivors to enter stage N3:

<i>Rule 2.102</i>	
	if ( $\text{Nauplius}_{\text{counter}} \geq 1$ ), change (N3)
<i>where:</i>	
$N_{\text{mp}}$	= 0.9 chances of mortality for a nauplius
change	= VEW function (see VEW 3.3 Handbook)

---

#### 45. Metamorphosis of N3, N4, N5

Rule 2.103

<i>Rule 2.103</i>	
	if ( $C_{\text{N\_Pool}} \geq N_{\text{jmin}}$ ), pchange (Nj)
<i>where:</i>	
$N_{\text{jmin}}$	= minimum protein pool for stage Nj
j	= 4, 5, 6 (copepod stages N4, N5, N6)

---

#### 46. Metamorphosis of N6, C1, C2

Rule 2.104

<i>Rule 2.104</i>	
	if ( $C_{\text{N\_Pool}} \geq C_{\text{jmin}}$ ), pchange (Cj)
<i>where:</i>	
$C_{\text{jmin}}$	= minimum protein pool for stage Cj
j	= 1, 2, 5 (copepod stages C1, C2, C3)

---

#### 47. Metamorphosis of C5

Rule 2.105

<i>Rule 2.105</i>	
	if ( $C_{\text{N\_Pool}} \geq C_{6\text{min}}$ ), pchange (C6)

### 48. Mortality due to starvation

A copepod can be ingested by a top predator or it may die by starvation or senescence. When the value of the carbon pool plunges under half the previous maximum value, the copepod dies by starvation. The spawning population is assumed to die of senescence at a randomly chosen date in the twenty days following reproduction (Woods and Barkmann, 1994).

Rule 2.106 defines the mortality due to starvation. This applies to all stages.

*Rule 2.106*

$$\text{if } (C_{N\_Pool} \leq \frac{C_{pmax}}{2}), \text{ change (Dead)}$$

where:

$C_{N\_Pool}$  = protein pool [mmol C]  
 $C_{pmax}$  = maximum carbon pool previously attained [mmol C]

### 49. Mortality due to senescence

After giving birth the mature copepod resume normal life (ingestion, gut processes, motility, etc.), but during the next 20 days their number is reduced linearly so that after 20 days they are all dead. This prevents a copepod to reproduce more than once.

Rule 2.107 defines the mortality due to senescence

*Rule 2.107*

$$A_r = (A_r + \text{TimeStep})$$

where:

$A_r$  = age since maturity [h]  
 $\text{TimeStep}$  = 0.5 [h]

Rule 2.108

*Rule 2.108*

$$\text{pchange (Dead, (if } (A_r < A_{rmax}) \text{ then } \frac{1}{(A_{rmax} - A_r)} \text{ else 1))}$$

where:

$A_r$  = age since maturity [h]  
 $A_{rmax}$  = 960 maximum life span since maturity [h]

### From the literature on mortality

The spawning population die of senescence at a randomly chosen date in the twenty days following reproduction (Woods & Barkmann, 1994).

#### Parameters values in the literature

$C_{pmax}$  = maximum protein pool [mmol C] for each growth stage, the value for each stage is in table 3.2 (after Carlotti and Wolf, 1998)

## 50. Excretion

Proteins and carapace each have a fixed N:C ratio. Lipids are assumed to be nitrogen free (Carlotti and Wolf, 1998). Nitrogen is excreted in the form of ammonia, whenever proteins are used to cover metabolic costs or when the maximum ratio of N:C is exceeded, and when lipids are built and the total N:C ratio changes depending on the ratio between  $C_N$  (proteins) and  $C_{NN}$  (lipids).

Rule 2.109 defines the excretion of nitrogen:

<i>Rule2.109</i>	
$C = (N_{\text{Prot}_{\text{excess}}} + C_{\text{prot}})$	
<i>where:</i>	
C	= total excreted nitrogen [mmol N]
$N_{\text{prot}_{\text{excess}}}$	= nitrogen in excess to maximum N:C ratio [mmolN]
$C_{\text{prot}}$	= nitrogen released when protein are catabolized [mmol N]

Rule 2.109 defines the release on the excreted nitrogen in the nitrogen in solution:

<i>Rule2.108</i>	
Release (C, Ammonium <sub>conc</sub> )	
<i>where:</i>	
C	= excreted nitrogen [mmol N]
Ammonium <sub>conc</sub>	= ammonium in solution [mmol N]

---

### From the literature on excretion

Proteins and carapace have a fixed N:C ratio, lipids are assumed to be nitrogen free. Nitrogen is excreted in the form of ammonia, whenever proteins are used to cover metabolic costs or when the maximum ratio of N:C is exceeded (Carlotti and Wolf, 1998).

## 51. Remineralisation

As a detritus particle sinks through the water, chemicals are leaked out its Droop pools and released to solution at its current depth. The rate of this remineralization depends on the mass of chemicals in the Droop pool. So the decline of that mass is experimental (as in radioactive decay).

Rule 2.111 defines the nitrogen remineralization:

<b>Rule 2.111</b>	$R_{nT} = 4.2E-3 \cdot 2.95^{((Temp+273) - 283/10)}$
<b>where:</b>	
$R_{nT}$	= nitrogen remineralisation rate [mmol N h <sup>-1</sup> ]
4.2E-3	= $N_{dissolution}$ N specific dissolution rate of N [mmol N mmolN <sup>-1</sup> h <sup>-1</sup> ]
2.95	= $Q_{RemN}$ factor to link N dissolution with Temp [dimensionless]
Temp	= temperature [°C]
283	= Tref [°K]

Rule 2.112 defines the silicate remineralization:

<b>Rule 2.112</b>	$R_{SiT} = 8.3E-4 \cdot 2.27^{((Temp+273) - 283/10)}$
<b>where:</b>	
$R_{SiT}$	= silicate remineralisation rate [mmol Si h <sup>-1</sup> ]
8.3E-3	= specific dissolution rate of Si [mmol Si mmolC <sup>-1</sup> h <sup>-1</sup> ]
2.27	= $Q_{RemN}$ factor to link Si dissolution with T [dimensionless]
Temp	= temperature [°C]
283	= Tref [°K]

Rule 2.113 defines the release of nitrogen in the water:

<b>Rule 2.113</b>	$\text{release}(\max(((\text{Ammonium}_{pool} + \text{Nitrate}_{pool}) R_{nT} \text{TimeStep}), 0.0), \text{Ammonium}_{conc})$
<b>where:</b>	
$R_{nT}$	= Nitrogen remineralisation rate [mmol N h <sup>-1</sup> ]
TimeStep	= 0.5 [h]

Rule 2.114 updates the pellet ammonium pool:

<b>Rule 2.114</b>	$\text{Ammonium}_{Pool} = \max(((\text{Ammonium}_{Pool} - (\text{Ammonium}_{Pool} R_{nT} \text{TimeStep})) + \text{Ammonium}_{ingested}), 0.0)$
<b>where:</b>	
$R_{nT}$	= Nitrogen remineralisation rate [mmol N h <sup>-1</sup> ]
TimeStep	= 0.5 [h]

Rule 2.115 updates the pellet nitrate pool:

**Rule 2.115**

$$\text{Nitrate}_{\text{Pool}} = \max(((\text{Nitrate}_{\text{Pool}} - (\text{Nitrate}_{\text{Pool}} R_{\text{NT}} \text{TimeStep})) + \text{Nitrate}_{\text{Ingested}}), 0.0)$$

where:

$R_{\text{NT}}$  = Nitrogen remineralisation rate [ $\text{mmol N h}^{-1}$ ]

TimeStep = 0.5 [h]

Rule 2.116 defines the release of silicate in solution:

**Rule 2.116**

release ( $\text{Silicate}_{\text{Ingested}}$ ,  $\text{Silicate}_{\text{Conc}}$ )

## **PART 3 – Carnivorous zooplankton**

Design considerations .....	137
Overview of Carnivores .....	140
State variables for Carnivores .....	141
Parameters for Carnivores .....	142
Chemical pools for Carnivores .....	144
Stages of Carnivores .....	145
Biological rules for Carnivores .....	146
1. Spawning .....	148
2. Embryogenesis .....	149
3. Physiological state at hatching .....	151
4. Time since hatching .....	158
5. Growth rate .....	159
6. Effect of size and temperature on swimming speed .....	160
7. Diel migration .....	161
8. Foraging .....	163
9. Swimming direction .....	165
10. Motility .....	166
11. Sinking of corpses .....	166
12. Ingestion .....	167
13. Digestion .....	170
14. Assimilation .....	173
15. Gut volume .....	176
16. Respiration: basal metabolic cost .....	177
17. Respiration: specific dynamic action cost .....	178
18. Respiration: cost of swimming .....	179
19. Energetics .....	182
20. Update gut content .....	184
21. Depth of egg mass .....	188
22. Update depth .....	188
24. Update yolk pool .....	190
25. Update lipid .....	191
26. Update protein .....	193
27. Total carbon .....	194
28. Weight .....	194
29. Mantle length .....	195
30. Update nitrogen pool .....	196
31. Mortality due to starvation .....	197
33. Excretion .....	199
34. Egestion .....	200
35. Pellet sinking .....	201
36. Pellet remineralisation .....	202
37. Metamorphosis from $S_j$ to $S_{(j+1)}$ .....	203
38. Recruits N release .....	204
39. N adjustment .....	205



## Design considerations

LERM is the first Lagrangian Ensemble biological model that includes an explicit population of carnivorous zooplankton. By explicit we mean that the population is represented by a set of computer agents, each of which behaves like a single plankter while carrying information about a dynamic sub-population of identical plankters. The biological functions of plankters associated with such agents are computed by phenotypic rules derived from the marine biology literature. The distinguishing feature of a dynamic population are the life histories of the plankters associated with each computer agent. The plankters in the dynamic sub-population of each computer agent have their own demography comprising time series of birth rate and death rate for each cause of death. The demography of the whole population is computed by summing the sub-population demographies over all the agents.

### Planktonic squid

The carnivorous zooplankton in LERM are planktonic squid. They are present in the virtual ecosystem from the date they are spawned to the date (about one month later) when the last one gets too big to be classified as plankton.<sup>11</sup> While in the planktonic stage the squid feed on copepods. Observations show that they change their diet once they attain a mantle length of 8mm, which is the LERM criterion for the squid emigrating from the virtual ecosystem.

### Other carnivores in LERM

The two populations of top predators (see Part 4) are also carnivorous plankton. One feeds on the copepods; the other feeds on the planktonic squid. They deplete the subpopulations of their prey, contributing to their death rate. That is a key computation for modelling fisheries recruitment. More generally it is important for modelling the trophic cascade.

However, being top predators, these carnivores are not dynamic populations like the squid. The difference is that the demography of each sub-population (and therefore the demography of the whole population) are not an emergent properties of the virtual ecosystem; they are computed from exogenous equations. That is the definition of a top predator.

### Staged growth

Squid hatch as miniature adults. They do not have a larval stage, which ends when they metamorphose to a fish stage, as happens in most fish. And squid do not have external shells that need to be shed periodically as they grow, which is the case for copepods. So there is no physiological requirement for

---

<sup>11</sup> Woods (2005) defines plankton as those aquatic organisms that cannot swim fast enough to change their ambient environment usefully by swimming horizontally. Of course many zooplankton do swim fast enough to change their ambient environment usefully by migrating vertically. This definition reflects the fact that the horizontal scale of environmental change is very much greater than the vertical scale. The Lagrangian Ensemble metamodel applies to plankton, but not necessarily to larger organisms such as fish. This is because there are no reliable phenotypic equations for learned behaviour of fish and marine mammals.

staged growth in LERM squid. Nevertheless there is a strong computational case for staging their growth, and that is one of the design features of LERM.

The computational case arises from the LE metamodel, which is expressed in all models created by VEW 3.3. One of the key features of the LE metamodel concerns the modelling of predation. The predator is not permitted to discriminate between the computer agents carrying the prey in the (one-metre thick) layer in the virtual mesocosm where the predator is located. It cannot select some of the prey and reject others, unless they are labelled in some way. VEW 3.3 supports labelling of a functional group by biological state, which can be alive or dead, or a growth stage. Using this facility the modeller can specify that a particular predator can only eat those preys that are in a particular growth stage. This permits selective feeding.

The modeller may find it useful to specify that the choice of prey growth stage changes as the predator becomes larger. This is achieved by dividing the life history of an individual predator into a sequence of biological states, which are defined by threshold body mass. This is merely a labelling device; it does not imply that the predator metamorphoses from one biological state to the next. That procedure is adopted in LERM for the planktonic squid. They pass through seven biological states, in each of which they feed on copepods of different sizes (growth stages).

The squid enters the seventh biological state when its mantle length is 8mm. It is then deemed to be no longer planktonic, but a small fish. It then stops feeding on copepods. It emigrates from the virtual ecosystem.

## **Squid growth**

The size of a squid is defined by its mass of carbon in the form of lipid and protein. LERM includes rules for diagnosing mantle length from its carbon mass.

## **Behaviour**

The LERM rules for squid diurnal migration and foraging are similar to those used for the copepods. The planktonic squid are only present in the virtual ecosystem during the spring, so there is no need to include rules for diapause.

## **Feeding**

The squid use vision to find their prey (copepods). The efficiency of this process depends on the visibility of individual copepods (see Part 2 above).

## **Food demand**

As in the copepods, LERM computes each squid's demand for food, on the basis of its size and the unfilled capacity of its gut. The actual ingestion depends on the ambient concentration of prey and their visibility. VEW 3.3 automatically scales back the ingestion of each squid if the visible prey concentration is insufficient to satisfy the total demand in each layer of the virtual mesocosm.

## **Gut processes**

The LERM rules for squid gut transit time and digestion are similar to those used for copepods, which appropriately scaled-up parameters.

## **Reproduction**

LERM squid are only present in the planktonic stage, which is too small for reproduction. Reproduction is modelled as an exogenous event, in which adult squid enter the virtual ecosystem briefly on a specified date each year for spawning. The result is a clutch of eggs, which hatch a few days later (depending on ambient temperature).

## **Inter-annual variation**

The number of eggs injected into the virtual ecosystem by each year's spawning event is specified as an exogenous property. In principle the number could be related to recruitment success in the previous year, but that is not done in LERM, which specifies the same number of eggs in the spawning event each year.

This design feature of LERM means that there is no demographic continuity in the squid population from year to year. Each year the squid population begins with the same number of eggs. The inter-annual variation in squid demography depends solely on the internal behaviour of the virtual ecosystem, which controls squid food, the copepods, which in turn depend on their food (the diatoms) and on depletion by the squid and top predators.

## Overview of Carnivores

The LERM is the first Lagrangian Ensemble model to include an explicit population of carnivorous zooplankton i.e. a population represented by a large number of computer agents behaving and growing like individual plankters.

In LERM the carnivorous plankton are squid paralarvae. They are present in LERM virtual ecosystem for about one month, from spawning to migration, which occurs when an individual exceeds a mantle length of 8 mm. While active in the virtual ecosystem the squid paralarvae are planktonic (i.e. they cannot usefully change their ambient environment by swimming horizontally). They are known to switch from a diet of copepod to other prey when their mantle length exceeds 8 mm.

The squid do not have a larval stage, as many carnivorous plankton and fish do. However LERM does distinguish between eggs and paralarvae. And for computational reasons (i.e. predator food preferences) LERM treats the paralarvae as seven growth stages, even though there is in reality neither metamorphosis nor moulting after hatching.

LERM squid are based on *Loligo opalescens*, which physiology and behaviour have been studied extensively. This is a small squid (mantle length up to 160mm) of the family of Loliginidae. It is found in the Eastern Pacific Ocean from Baja Mexico to Alaska at latitudes similar to that of the Azores site. The squid lives less than one year.

## State variables for Carnivores

$C_{\text{pool}}$	$= C_{\text{Npool}} + C_{\text{NNpool}}$	
$C_{\text{NNpool}}$	$= C_{\text{Nnpool}} + \text{Budg}_{\text{CNN}} - \text{Lip}_{\text{excess}}$	
$C_{\text{Npool}}$	$= C_{\text{N\_pool}} + \text{Budg}_{\text{CN}}$	
$N_{\text{pool}}$	$= N_{\text{poo}} + N_{\text{ingested}} - [(C \text{ TimeStep}) + (E_{\text{protein}} Q_{\text{Nprotein}})]$	
$DW$	$= \text{Carbon}_{\text{Npool}} C_{\text{conv}}$	
$WW$	$= (DW - 0.064) / 0.21$	from Vidal <i>et al.</i> (2002)
$ML$	$= 10^{[(\log DW + 1.22)/2.37]}$	
$MW$	$= 0.3768ML + 0.7842 \text{ [mm]}$	from Vecchione (1981)
$S$	$= \pi (MW/2)^2 \text{ [mm}^2\text{]}$	

### Where

$\text{Budg}_{\text{CN}}$	= flux of body protein [mmol C]
$\text{Budg}_{\text{CNN}}$	= flux of body lipid [mmol C]
$C$	= Ammonium excretion rate [mmol N h <sup>-1</sup> ]
$C_{\text{conv}}$	= 12 [mg C mmol C <sup>-1</sup> ]mmol C to mg C conversion factor
$C_{\text{N\_Pool}}$	= Protein pool [mmol C]
$C_{\text{NNpool}}$	= Lipid pool [mmol C]
$C_{\text{pool}}$	= total carbon pool [mmol C]
$DW$	= Dry weight [mgC]
$E_{\text{protein}}$	= Protein not assimilated [mmol C]
$\text{Lip}_{\text{excess}}$	= excess lipids [mmol C]
$ML$	= Mantle length [mm]
$MW$	= Mantle width [mm]
$N_{\text{ingested}}$	= Nitrogen ingested during last timestep [mmol N]
$N_{\text{pool}}$	= Nitrogen pool [mmol N]
$Q_{\text{Nprotein}}$	= nitrogen:carbon ratio in protein [mmol N mmolC <sup>-1</sup> ]
$S$	= Frontal surface area visible from above [mm <sup>2</sup> ]

## Parameters for Carnivores

Parameter	Description	Value	Unit	Source
A	Basal respiration parameter2	1.0879	dimensionless	O'Dor <i>et al.</i> , 1986
Aeff_lip	Assimilation efficiency for lipid	0.5	dimensionless	
Aeff_prot	Assimilation efficiency for protein	0.85	dimensionless	
B	Basal respiration parameter1	123.7	dimensionless	O'Dor <i>et al.</i> , 1986
C_conv2	C_conv2	0.012	g C mmolC <sup>-1</sup>	calculated
DAT_hatch	DAT threshold for hatching	600	°C days	Baron, 2000
E_conv	Energy conversion	4.6	cal l <sup>-1</sup>	
E_conv2	Conversion coefficient from Watts to calories per day	20635	W to cal d <sup>-1</sup>	O'Dor <i>et al.</i> , 1986
E_conv2	Energy conversion	20635	J g <sup>-1</sup>	
En_lip	Energy content of copepod lipid	9000	cal g <sup>-1</sup>	
En_prot	Energy content of copepod protein	5700	cal g <sup>-1</sup>	
G_Conv	mmolC to microgC conversion factor	12000	µg C mmolC <sup>-1</sup>	calculated
G_max	Maximum weight	0.62	g	
ML_max	Maximum ML	8	mm	Yang <i>et al.</i> , 1986
Protein_inProp	Protein proportion	0.85	dimensionless	
Q_lipMax	Maximum ratio of lipids to DW	0.15	dimensionless	Lee, 1994
Q_Nprot	N:C ratio in proteins	0.15	dimensionless	Lee, 1994
Q_PLused	Ratio of protein to lipid catabolism	0	dimensionless	
QR10	Increase of digestion with T	2	dimensionless	
R_N	Nitrogen rate of remineralization for 10°C increase	0.0042	mmolN mmolN <sup>-1</sup> h <sup>-1</sup>	
r_sda	Cost of somatic growth parameter	0.2	dimensionless	Parry, 1983
S2_ML	Minimum ML for S2	3	mm	assumed
S3_ML	Minimum ML for S3	4	mm	assumed
S4_ML	Minimum ML for S4	5	mm	assumed

LERM – Technical documentation

S5_ML	Minimum ML for S5	6	mm	assumed
S6_ML	Minimum ML for S6	7	mm	assumed
S7_ML	Minimum ML for S7	8	mm	assumed
S_max	Maximum frontal area	$1.0 \times 10^{-5}$	m <sup>2</sup>	
S_maxIsolume	Ref max Sa for target isolume	$5.0 \times 10^{-6}$	m <sup>2</sup>	
Spawning_date	Date of spawning	100	Days from 1 <sup>st</sup> Jan	
T_ref	Reference temperature	10	°C	
T_ref2	Reference temperature for digestion	20	°C	
Ts	Time step	0.5	h	Barkmann&Woods, 1994
v	Coefficient of kinematic viscosity	$1.0 \times 10^{-6}$	m <sup>2</sup> s <sup>-1</sup>	
v_gut	Stomach volume coefficient	0.2	mm <sup>3</sup>	
V_max	Maximum swimming speed	135	mh <sup>-1</sup>	
Vis_IrradRef	Reference irradiance	1	dimensionless	assumed
W_conv	mgC to mmolC conversion factor	0.0833	mmolC mgC <sup>-1</sup>	calculated
V_sink squid	Sinking speed of dead squid	20	m h <sup>-1</sup>	assumed
V_sink pellet	Sinking speed of faecal pellets	10	m h <sup>-1</sup>	assumed
Yolk_lipidsRatio	Ratio Yolk:Wet Weight	0.15	mmol	Bouchaud and Galois, 1990
YolkE_cont	Yolk energetic value	1.71	cal mgC <sup>-1</sup>	Giese, 1969
z_egg	Depth of egg mass	50	m	Zeidberg and Hamner, 2002

Table 3.1 – Squid parameters

## Chemical pools for Carnivores

Squid have a stoichiometry unlike that of most carnivorous plankton and fish. An individual's wet weight is made up by 18% protein, 79% water with just 3% left for all other biochemical compounds needed for life.

In contrast to fishes, cephalopods contain 20% more protein, 80% less ash, 50-100% less lipid and 50-100% less carbohydrate (Bouchaud and Galois, 1990; Lee, 1994).

Lee (1994) reported lipid contents of cephalopods ranging between 0.34-3.4% wet weight. Bouchaud and Galois (1990) in laboratory experiments on *Sepia officinalis* found that hatchlings' lipid content was close to 15% dry weight, independently of temperature and duration of development. Assuming a body water percentage of 75-80%, the total lipids content is 3-4 % wet weight.

In LERM each squid has a pool for each of the chemicals present in copepods.

Carbon ingested is allocated to proteins and lipids. In LERM squid have a maximum dry weight mass of lipid. Body nitrogen is coupled to protein-mass through a fixed ratio (0.15 mmolN mmolC<sup>-1</sup>).

The amount of ingested carbon allocated to lipid reserve per timestep depends on the state of development (represented in LERM by growth stage).

A	Min	Max	Units	Functions
C	0.05	0.70	mmol C	State variable
Protein, C <sub>NN</sub>	0.05	0.70	mmol C	State variable
Lipid, , C <sub>NN</sub>	0	0.09	mmol C	State variable
N	7.50 x10 <sup>-3</sup>	0.10	mmol N	State variable

B	Min	Max	Units	Functions
N:C	0.13	0.15	mmol N: mmol C	Excretion

Table 3.2 a) stoichiometry and b) cellular ratio of chemicals in LERM squid.



## Stages of Carnivores

Squid body growth is continuous and unstaged, unlike copepods, whose growth is staged for moulting of the carapace. However, in order to allow for size specific predation by the visual top predator (Table.3.2), squid paralarvae have been allocated to size classes S1 to S7, based on their mantle length (ML). A small paralarvae is less visible to visual top predators than a large one, but is slower in its escape. S1 represents the squid at hatching, S7 represents the recruited squid, which leaves the virtual mesocosm. A squid can only be in one particular development stage at any time. As it grows and its ML increases by one millimetre it moves into the next stage (fig. 3.1).

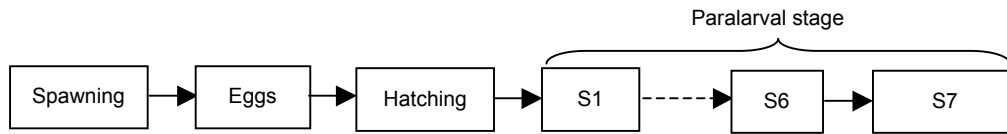

Fig.3.1 – Squid stages

STAGE	Max ML [mm]	MW [mm]	DW [mgC]	DW [mmolC]	S [m <sup>2</sup> ]	AveDW [mmolC]	Ave S [m <sup>2</sup> ]	Max speed [mh <sup>-1</sup> ]
S1	2.80	1.84	0.69	0.06	2.7 x 10 <sup>-6</sup>	0.06	2.8 x 10 <sup>-6</sup>	52
	2.99	1.92	0.81	0.07	2.9 x 10 <sup>-6</sup>			
S2	3.00	1.92	0.81	0.07	2.9 x 10 <sup>-6</sup>	0.10	3.5 x 10 <sup>-6</sup>	63
	3.99	2.30	1.60	0.13	4.1 x 10 <sup>-6</sup>			
S3	4.00	2.30	1.61	0.13	4.1 x 10 <sup>-6</sup>	0.18	4.9 x 10 <sup>-6</sup>	81
	4.99	2.68	2.72	0.23	5.6 x 10 <sup>-6</sup>			
S4	5.00	2.68	2.73	0.23	5.6 x 10 <sup>-6</sup>	0.29	6.5 x 10 <sup>-6</sup>	99
	5.99	3.06	4.19	0.35	7.4 x 10 <sup>-6</sup>			
S5	6.00	3.06	4.21	0.35	7.4 x 10 <sup>-6</sup>	0.43	8.3 x 10 <sup>-6</sup>	117
	6.99	3.44	6.05	0.50	9.3 x 10 <sup>-6</sup>			
S6	7.00	3.44	6.07	0.51	9.3 x 10 <sup>-6</sup>	0.60	1.0 x 10 <sup>-6</sup>	135
	7.99	3.82	8.30	0.69	11.0 x 10 <sup>-6</sup>			
S7	≥8.00	-	-	-	-	-	-	-

Tab. 3.2 Squid growth stages in LERM. ML: mantle length, MW: mantle width, DW: dry weight, S: frontal surface area, AVE DW: dry weight, AVE S: surface area

In LERM, the biological state of a squid is determined by two factors: (i) its virtual growth stage, and (ii) the mass of chemicals in each of its Droop pools. These are factors that are used in phenotypic rules to update its biological state at each time step in the integration. Some of the rules determine when the squid will metamorphose from its current growth stage to the next.

LERM does not include a respiration cost of this virtual metamorphosis of the squid. All the chemicals in Droop pools are inherited in the next stage.

## **Biological rules for Carnivores**

1. Spawning
2. Embryogenesis
3. Physiological state at hatching
4. Time since hatching
5. Growth rate
6. Effect of size & temperature on swimming
7. Diel migration
8. Foraging
9. Swimming direction
10. Motility
11. Sinking
12. Ingestion
13. Digestion
14. Assimilation
15. Gut processes
16. Respiration: Basal metabolic cost
17. Respiration: Specific dynamic action cost
18. Respiration: Swimming cost
19. Energetics
20. Update gut content
21. Depth of egg mass
22. Update depth
23. Hatching
24. Update yolk pool
25. Update lipid
26. Update protein
27. Total carbon
28. Weight
29. Mantle length
30. Update Nitrogen pool
31. Mortality due to starvation
32. Remineralization of corpses
33. Excretion

- 34. Egestion
- 35. Pellet sinking
- 36. Pellet remineralization
- 37. Metamorphosis from  $S_j$  to  $S_{(j+1)}$
- 38. Recruits N release
- 39. N adjustment
- 40. Recruitment annual reset

## 1. Spawning

An exogenous population of mature squid lays a batch of eggs at a given depth on a given date<sup>12</sup>. Spawners exit the mesocosm immediately after laying the eggs.

Rule 3.1 defines the date of spawning:

*Rule 3.1*

if ( $d_{\text{year}} \geq d_0$ ), change(Egg)

*Where*

$d_{\text{year}}$  = days since 1<sup>st</sup> January

$d_0$  = 100 [days] spawning day since 1<sup>st</sup> January (10 April)

---

<sup>12</sup> Typically 300 eggs/m<sup>2</sup> at 50 m on the 10<sup>th</sup> of April. This spawning event is repeated each year. The number of eggs is not a function of emergent recruitment in the previous year.

## 2. Embryogenesis

Embryonic development is computed using daily accumulated temperature (DAT) following common practice in modelling loliginid species (Baron, 2000). DAT is accumulated from the time eggs are laid. Eggs hatch when DAT exceeds 600 [°C days]. The eggs introduced by spawning all hatch within 4-6 days.

The intra-population variability in hatching date is modelled as a variation of the initial DAT and justified as a parameterization of the variation in egg size, which in is not modelled explicitly in LERM.

Rule 3.2 defines the DAT:

<i>Rule 3.2</i>	
	(TempTimeStep)
	$\text{DAT} = (\text{if } (d_{\text{year}} \geq 0.0) \text{ then } (\text{DAT} + \frac{\text{TempTimeStep}}{24}) \text{ else } 0.0)$
<i>Where</i>	
DAT	= [°C days] daily accumulated temperature
$d_{\text{year}}$	= days since 1 <sup>st</sup> January
Temp	= ambient temperature [°C]
TimeStep	= 0.5[h]

Rule 3.3 records the number of timesteps (0.5 h) since spawning:

<i>Rule 3.3</i>	
	$\text{Incubation}_{\text{time}} = (\text{if } (d_{\text{year}} \geq 0.0) \text{ then } (\text{Incubation}_{\text{time}} + 1) \text{ else } 0.0)$
<i>Where</i>	
$d_{\text{year}}$	= days since 1 <sup>st</sup> January
$\text{Incubation}_{\text{time}}$	= number of timesteps since spawning [dimensionless]

Rule 3.4 records the accumulated temperature during the incubation period:

<i>Rule 3.4</i>	
	$T_{\text{acc}} = (\text{if } (d_{\text{year}} \geq 0) \text{ then } (T_{\text{acc}} + \text{Temp}) \text{ else } 0.0)$
<i>Where</i>	
$d_{\text{year}}$	= days since 1 <sup>st</sup> January
$T_{\text{acc}}$	= accumulated temperature [°C]
Temp	= temperature [°C]

Rule 3.5 defines the mean incubation temperature:

*Rule 3.5*

$$\text{MIT} = (\text{if } (d_{\text{year}} \geq 0) \text{ then } \frac{T_{\text{acc}}}{\text{Incubation}_{\text{time}}} \text{ else } 0.0)$$

*Where*

- MIT = Mean Incubation Temperature [°C]
- $d_{\text{year}}$  = days since 1<sup>st</sup> January
- $T_{\text{acc}}$  = accumulated temperature since spawning
- $\text{Incubation}_{\text{time}}$  = number of timesteps elapsed since eggs where laid

### 3. Physiological state at hatching

LERM squid para-larvae hatch with variable sizes and yolk reserves. The lipid content varies with incubation temperature and size. Rule 3.6 defines the mantle length at hatching:

**Rule 3.6**

$$ML_{Temp} = ((-0.05 MIT) + 3.54)$$

**Where**

$ML_{Temp}$	= Mean Mantle Length at hatching [mm]
MIT	= Mean Incubation Temperature [°C]
0.05	= coefficient [mm °C <sup>-1</sup> ] from Baron (2003)
3.54	= coefficient [mm] from Baron (2003)s

Mantle width (MW) is calculated using the relationship between ML and MW for *L. pealei* (comparable size with *L. opalescens*) reared in laboratory (Vecchione, 1981). Rule 3.7 defines the mantle width at hatching:

**Rule 3.7**

$$MW_{Temp} = ((0.38 ML_{Temp}) + 0.78)$$

**Where**

$MW_{Temp}$	= mantle width at hatching [mm]
$ML_{Temp}$	= mantle length at hatching [mm]
0.38	= coefficient [dimensionless]
0.78	= coefficient [mm]

The wet weight of the newly hatched squid is function of its ML. It is calculated using the phenotypic equation obtained for *Loligo opalescens* juveniles (Forsythe and Van Heukelem, 1987). Rule 3.8 defines wet weight at hatching:

**Rule 3.8**

$$WW_{Temp} = (1.94 \times 10^{-4} ML_{Temp}^{2.59} 1000)$$

**Where**

$WW_{Temp}$	= wet weight at hatching [mg]
$ML_{Temp}$	= mantle Length at hatching [mm]

The dry weight is correlated to wet weight using the following lab derived correlation (Vidal *et al.*, 2002). Rule 3.9 defines the dry weight at hatching:

**Rule 3.9**

$$DW_{Temp} = ((0.21 + WW_{Temp}) + 0.064)$$

**Where**

$DW_{Temp}$	= dry weight at hatching [mg]
$WW_{Temp}$	= wet weight at hatching [mg]

**Gut volume.** Rule 3.10 defines the gut volume at hatching:

*Rule 3.10*

$$V_{\text{gut}} = (ML_{\text{Temp}} V_{\text{gut}})$$

*Where*

$V_{\text{gut}}$  = gut volume [mm<sup>3</sup>]

$V_{\text{gut}}$  = 0.2 gut volume coefficient [mm<sup>2</sup>]

$ML_{\text{Temp}}$  = mantle length [mm]

### **Chemical pools at hatching**

Cephalopods contain 20% more protein, 80% less ash, 50-100% less lipid and 50-100% less carbohydrate than fish.

Assuming a body water percentage of 77.5% (75-80% Lee, 1994), the total lipids content is 15 % DW. LERM, therefore, assumes that the maximum body lipid is 15% (Galois, 1990).

Rule 3.11 computes the protein pool at hatching:

*Rule 3.11*

$$C_{\text{N\_PoolTemp}} = (DW_{\text{Temp}} \text{Protein}_{\text{inProp}} W_{\text{conv}})$$

*Where*

$C_{\text{N\_PoolTemp}}$  = protein pool at hatching [mmol C]

$DW_{\text{Temp}}$  = dry weight at hatching [mg]

$\text{Protein}_{\text{inProp}}$  = 0.85 max protein percentage of body weight [dimensionless]

$W_{\text{conv}}$  = 0.0833 mg C to mmol C conversion factor [mmolC mg<sup>-1</sup>]

Rule 3.12 computes the lipid pool at hatching:

*Rule 3.12*

$$C_{\text{NN\_PoolTemp}} = (DW_{\text{Temp}} (1 - \text{Protein}_{\text{inProp}}) W_{\text{conv}})$$

*Where*

$C_{\text{NN\_PoolTemp}}$  = Lipid pool at hatching [mmol C]

$DW_{\text{Temp}}$  = dry weight at hatching [mg]

$\text{Protein}_{\text{inProp}}$  = 0.85 max protein percentage of body weight [wd]

$W_{\text{conv}}$  = 0.0833 mg C to mmol C conversion factor [mmol C mg<sup>-1</sup>]



Rule 3.13 computes the carbon pool at hatching:

**Rule 3.13**

$$\text{Carbon}_{\text{Pool}} = (\text{C}_{\text{NN\_PoolTemp}} + \text{C}_{\text{N\_PoolTemp}})$$

*Where*

$\text{Carbon}_{\text{Pool}}$  = Carbon pool at hatching [mmolC]  
 $\text{C}_{\text{N\_PoolTemp}}$  = Protein pool at hatching [mmolC]  
 $\text{C}_{\text{NN\_PoolTemp}}$  = Lipid pool at hatching [mmolC]

Rule 3.14 computes the nitrogen pool at hatching:

**Rule 3.14**

$$\text{Ammonium}_{\text{Pool}} = (\text{C}_{\text{N\_PoolTemp}} \cdot \text{Q}_{\text{Nprot}})$$

*Where*

$\text{Ammonium}_{\text{Pool}}$  = Nitrogen pool at hatching [mmolN]  
 $\text{C}_{\text{N\_PoolTemp}}$  = Protein pool at hatching [mmolC]  
 $\text{Q}_{\text{Nprot}}$  = 0.15 nitrogen to protein pool ratio [mmolN mmolC<sup>-1</sup>]

Rule 3.15 computes the nitrogen pool at hatching:

**Rule 3.15**

$$\text{Q}_{\text{N}} = (\text{if } (\text{Carbon}_{\text{Pool}} > 0.0) \text{ then } \frac{\text{Ammonium}_{\text{Pool}}}{\text{Carbon}_{\text{Pool}}} \text{ else } 0.0)$$

*Where*

$\text{Q}_{\text{N}}$  = Nitrogen to carbon pool ratio [mmol N mmol C<sup>-1</sup>]  
 $\text{Ammonium}_{\text{Pool}}$  = Nitrogen pool at hatching [mmol N]  
 $\text{Carbon}_{\text{Pool}}$  = Carbon pool at hatching [mmol C]

### **Yolk reserve**

Rule 3.16 defines the energy stored in yolk (from Vidal *et al.*, 2002):

**Rule 3.16**

$$\text{Yolk}_{\text{lipids}} = (\text{Yolk}_{\text{lipidsRatio}} \cdot \text{WW}_{\text{temp}} \cdot \text{YolkE}_{\text{cont}})$$

*Where*

$\text{Yolk}_{\text{lipids}}$  = energy in yolk [cal]  
 $\text{Yolk}_{\text{lipidsRatio}}$  = 0.15 [mgC mgC<sup>-1</sup>] yolk weight as percentage of WW  
 $\text{WW}_{\text{temp}}$  = wet weight at hatching [mgC]  
 $\text{YolkE}_{\text{cont}}$  = 1.71 [cal mgC<sup>-1</sup>] yolk energetic value

Rule 3.17 defines the mantle length:

<b>Rule 3.17</b>	$ML = ML_{Temp}$
<b>Where</b>	
ML	= Mantle length [mm]
ML <sub>Temp</sub>	= Mantle length at hatching [mm]

Rule 3.18 defines the mantle width:

<b>Rule 3.18</b>	$MW = MW_{Temp}$
<b>Where</b>	
MW	= Mantle width [mm]
MW <sub>Temp</sub>	= Mantle width at hatching [mm]

Frontal surface area (S) is assumed to be the area of the squid visible from above. This is assumed to be a circle, whose diameter is represented by MW. Frontal surface area is converted from [mm<sup>2</sup>] to [m<sup>2</sup>] to calculate the visibility, where irradiance is [Wm<sup>-2</sup>]. Rule 3.19 defines the frontal surface area:

<b>Rule 3.19</b>	$S = (PI \frac{MW_{Temp}}{2})^2 \cdot 1 \times 10^{-6}$
<b>Where</b>	
PI	= 3.14 ( $\pi$ )
S	= frontal surface area [m <sup>2</sup> ]
MW <sub>Temp</sub>	= Mantle width at hatching [mm]

Rule 3.20 updates the mantle length:

<b>Rule 3.20</b>	$WW = WW_{Temp}$
<b>Where</b>	
WW	= wet weight at hatching [mg]
WW <sub>Temp</sub>	= wet weight at hatching [mg]

Rule 3.21 updates the protein pool:

<b>Rule 3.21</b>	$C_{N\_Pool} = C_{N\_PoolTemp}$
<b>Where</b>	
C <sub>N_Pool</sub>	= protein pool [mmol C]
C <sub>N_PoolTemp</sub>	= protein pool at hatching [mmol C]

Rule 3.22 updates the lipid pool:

<i>Rule 3.22</i>	$C_{NN\_Pool} = C_{NN\_PoolTemp}$
<i>Where</i>	
$C_{NN\_Pool}$	= lipid pool [mmol C]
$C_{NN\_PoolTemp}$	= lipid pool at hatching [mmol C]

Rule 3.23 records the dry weight at hatching:

<i>Rule 3.23</i>	$DW_0 = DW_{Temp}$
<i>Where</i>	
$DW_0$	= dry weight at hatching [mg]
$DW_{Temp}$	= dry weight at hatching [mg]

Rule 3.24 updates the dry weight:

<i>Rule 3.24</i>	$DW = DW_{Temp}$
<i>Where</i>	
$DW$	= dry weight [mg]
$DW_{Temp}$	= dry weight at hatching [mg]

Rule 3.25 defines the start of the paralarval phase:

<i>Rule 3.25</i>	change(S1)
<i>Where</i>	
change	= VEW function (see VEW 3.3 Handbook)

Rule 3.26 defines the removal of N equivalent to the introduction of body N in the immigrating squid from a depth 450m (chemical budgeting):

<i>Rule 3.26</i>	
Create	( $N_{adjuster}, 1$ )
	$z = 450$
	$Excess_N = (C_{N\_PoolTemp} Q_{Nprot})$
<i>Where</i>	
Create	= VEW function (see VEW 3.3 Handbook)
$N_{adjuster}$	= pseudo-stage of squid set at 450m to take account of N introduced in immigrant squids
$z$	= depth [m]
$Excess_N$	= Body nitrogen introduced by immigrating squid [mmolN]
$C_{N\_PoolTemp}$	= Protein pool at hatching [mmolC]
$Q_{Nprot}$	= 0.15 nitrogen to protein pool ratio [mmolN mmolC <sup>-1</sup> ]

## From the literature on squid hatching

*Loligo opalescens* spawning occurs in Monterey Bay from April to November (Zeidberg and Hamner, 2002). Inshore loliginid squid, such as *L. opalescens*, spawn elongated gelatinous egg capsules, which may contain from a few to over 100 eggs, depending on the species.

Species	Egg length (mm)	ML at hatching (mm)
<i>Loligo gahi</i>	2.1-3.0 (Baron, 2001)	2.3-3.7 (Baron, 2003)
	2.5-3.2 (Guerra <i>et al.</i> , 2001)	2.6-3.1 (Guerra <i>et al.</i> , 2001)
<i>Loligo opalescens</i>	2.0-2.5 (Fields, 1965)	2.5-3.2 (McConathy <i>et al.</i> , 1980)
<i>Loligo bleekeri</i>	2.6-2.7 (Baeg <i>et al.</i> , 1993)	3.0-3.3 (Baeg <i>et al.</i> , 1993))
<i>Loligo vulgaris</i>	2.3-2.7 (Worms (1983)	2.8-3.3 (Hanlon <i>et al.</i> , 2002;)
<i>Loligo sanpaulensis</i>	1.2-1.3 (Baron, 2001)	1.4-1.7 (Baron, 2003)

Table 3.3 - Egg diameter and mantle length at hatching for different squid species.

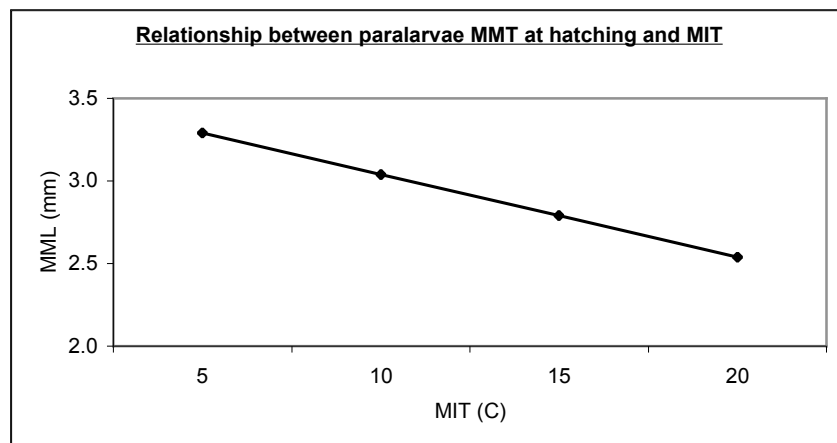

Fig. 3.1– Mantle length (MMT) at hatching against mean incubation temperature (MIT) (Baron, 2003).

In nature the duration of cephalopod embryogenesis depends mainly on egg size and ambient temperature (Laptikhovskiy, 1991). Embryonic development for *L. opalescens* requires 30-40 days at 15°C (Yang *et al.*, 1986). LERM assumes that all eggs have the same size, so that temperature is the only factor affecting the duration of embryogenesis. Lee (1994) reported lipid contents of cephalopods ranging between 0.34-3.4% wet weight.

Regression equations are used to link incubation temperature to the size of the hatchling (mantle length and width, frontal surface area, protein, lipid and nitrogen pools). The average size of *L. gahi* at hatching is inversely correlated with incubation temperature (Baron, 2003) by this regression equation ( $r^2 = 0.83$ ,  $n = 241$ ).

Egg yolk lipid is 15% wet weight of the paralarva at hatching (Bouchaud and Galois, 1990; Vidal *et al.*, 2002). Body nitrogen is coupled to protein through a fixed proportion (15%). The yolk reserve at hatching is therefore assumed to be 15% of the wet weight at hatching and is converted into energy content.

Squid paralarvae hatch at night (Fields, 1965), when visual predators are not feeding. In *L. opalescens* and *L. forbesi*, the period from the first paralarva hatching to the emergence of the last took 4-6 and 7 days, respectively (Yang *et al.*, 1986; Segawa *et al.*, 1988 From Arkhipkin and Middleton, 2003 pp 132).

Young cephalopods in their first growth stage after hatching resemble miniature adults with most organs developed, but their planktonic mode of life differs from that of juveniles and adults (Baron, 2003). For this reasons they are different from others molluscs larvae and are referred to as paralarvae (Young and Harman, 1988).

Experiments on *L. opalescens* show that the weight and volume of yolk reserves in hatchlings vary with the temperature during embryogenesis. They observed that *L. opalescens* hatching at 12°C were larger, heavier and had more yolk than squid hatching at 16°C (Vidal *et al.*, 2002). This study showed that the yolk-weight to body-weight ratio at hatching was not significantly different for the two temperature groups, indicating that the amount of yolk is proportional to body weight.

Yolk absorption rate during the very early post-embryonic life, embryonic and post-embryonic nutrition overlap (Vidal *et al.*, 2002)

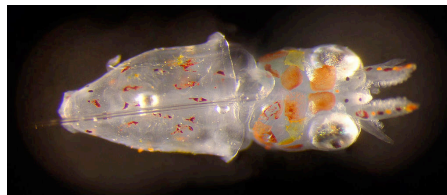

Fig. 3.2 - *Loligo opalescens* paralarva ([www.flickr.com/photos/toddography/38447140](http://www.flickr.com/photos/toddography/38447140))

---

#### *Parameters values in the literature*

Caloric value of *L. opalescens* yolk = 1.71 cal mg<sup>-1</sup>  
(Giese, 1969)

#### 4. Time since hatching

Rule 3.27 defines the time since hatching in hours:

*Rule 3.27*

$$\text{TEMPT}_{\text{hatch}} = (\text{TEMPT}_{\text{hatch}} + \text{TimeStep})$$

*where:*

$\text{TEMPT}_{\text{hatch}}$  = temporary time since hatching [h]  
 $\text{TimeStep}$  = 0.5 [h]

Rule 3.28 defines the time since hatching in days:

*Rule 3.28*

$$\text{Time}_{\text{hatch}} = \frac{\text{TEMPT}_{\text{hatch}}}{24}$$

*where:*

$\text{Time}_{\text{hatch}}$  = time since hatching [d]  
 $\text{TEMPT}_{\text{hatch}}$  = temporary time since hatching [h]

## 5. Growth rate

Rule 3.29 defines daily percentage change in dry weight:

**Rule 3.29**

$$G_{\text{rate}} = \frac{\frac{(DW - DW_0)}{DW_0} \cdot 100}{\text{Time}_{\text{hatch}}}$$

*where:*

- $G_{\text{rate}}$  = daily percentage change in dry weight [ $\text{day}^{-1}$ ]
- $DW$  = dry weight [mg]
- $DW_0$  = initial dry weight [mg]
- $\text{Time}_{\text{hatch}}$  = time since hatching [day]

Rule 3.30 defines the feeding history index used to calculate mortality:

**Rule 3.30**

$$d_{\text{feed}} = (\text{if } G_{\text{rate}} > 0.0) \text{ then } \frac{\log_{10}(DW/DW_0)}{\log_{10}(2.718)} \text{ else } 0.0$$

*where:*

- $d_{\text{feed}}$  = feeding history index [dimensionless]
- $G_{\text{rate}}$  = growth rate [dimensionless]
- $DW$  = dry weight [mg]
- $DW_0$  = initial dry weight [mg]
- $\text{Time}_{\text{hatch}}$  = [h] time since hatching
- 2.718 = initial dry weight

*Rule 3.30 has been superseded by rule 3.77*

## 6. Effect of size and temperature on swimming speed

Rule 3.31 defines the effect of T on maximum swimming migration speed

### Rule 3.31

$$W_z = ((0.3 + (0.7 \text{ Temp}/T_{\text{ref}})) \min((S/S_{\text{max}}), 1))$$

where:

$W_z$  = effect of temperature and size on swimming speed [dimensionless]

Temp = ambient temperature [°C]

$T_{\text{ref}}$  = 10 [°C] reference temperature

S = frontal surface area [m<sup>2</sup>]

$S_{\text{max}}$  =  $1.1 \times 10^{-5}$  [m<sup>2</sup>] frontal surface area for a stage S6 squid

0.3 = coefficient from Woods&Barkmann (1994)

0.7 = coefficient from Woods&Barkmann (1994)

---

### From the literature on motility

Squid paralarvae are defined as plankton; i.e. they cannot swim fast enough to change their local environment by swimming horizontally (Woods, 2002). They can swim vertically (Zeidberg and Hamner, 2002). They migrate in the virtual mesocosm at a migration speed which is about 40 % less than the maximum jet speed used to escape attacks (Zeidberg, 2004).



## 7. Diel migration

Diel migration is modelled in terms of the squid pursuing a target isolume, as for copepods (Woods and Barkmann, 1994). During the day a squid keeps to a depth at which irradiance is low enough to reduce the risk of being eaten. This depth is a function of squid visibility. Squid visibility is determined by its size and ambient irradiance.

Predator-prey encounter occurs during the day (from dawn until dusk) as they both migrate in the virtual mesocosm following of their target isolume.

At dusk (irradiance  $< 100 \text{ Wm}^{-2}$ ) squids ascend the water column. At dawn (irradiance  $> 100 \text{ Wm}^{-2}$ ) squid descends the water column chasing its target isolume  $I_t$ .

Rule 3.32 defines the squid target isolume:

<b>Rule 3.32</b>	
$I_t = (S_{\max} / S) (1.5 - \text{Gut}_{\text{Temp}})$	
<i>where:</i>	
$I_t$	= target isolume [ $\text{W m}^{-2}$ ]
$S$	= frontal surface area [ $\text{m}^2$ ]
$S_{\max}$	= $1 \times 10^{-5}$ [ $\text{m}^2$ ] frontal surface area for a S6 squid
$\text{Gut}_{\text{Temp}}$	= gut fullness [dimensionless] $0 < \text{Gut}_{\text{Temp}} < 1$
1.5	= coefficient adapted from Woods&Barkmann (1994)

Rule 3.33 computes the depth of the target isolume:

<b>Rule 3.33</b>	
$\text{Depth}_{I_t} = \text{DepthForVI}(I_t)$	
<i>where:</i>	
$\text{Depth}_{I_t}$	= depth of target isolume [m]
$\text{DepthForVI}$	= VEW function (see VEW 3.3 Handbook)
$I_t$	= target isolume [ $\text{W m}^{-2}$ ]

After noon, the squid ascends in pursuit of their target isolume rising toward the sea surface.

Rule 3.34 defines the percentage of maximum velocity used in pursuing the target isolume:

**Rule 3.34**

$$kd_{calc} = \text{(if (z < Depth}_{it}) \text{ then (if ((Depth}_{it} - z) > (0.6 V_{max} \text{ TimeStep } W_z)) \text{ then } 0.6 \frac{(\text{Depth}_{it} - z)}{(V_{max} \text{ TimeStep } W_z)} \text{ else (if ((z - Depth}_{it}) > V_{max} \text{ TimeStep } W_z \cdot 0.6)) \text{ then } -0.6 \frac{(\text{Depth}_{it} - z)}{(V_{max} \text{ TimeStep } W_z)} \text{ else } \frac{(\text{Depth}_{it} - z)}{(V_{max} \text{ TimeStep } W_z)})$$

*where:*

- $kd_{calc}$  = target isolume index [dimensionless]  $-1 \leq kd_{calc} \leq 1$  the value gives the percentage of the maximum speed, the sign gives the direction of migration (negative upwards migration, positive downwards)
- $Depth_{it}$  = depth of target isolume [m]
- $z$  = depth [m]
- $V_{max}$  = 135 [ $mh^{-1}$ ] maximum swimming speed
- $W_z$  = effect of temperature & size on swimming speed [dimensionless]
- 0.6 = routine speed is 60 % of the maximum swimming speed

Rule 3.35 defines the swimming direction during daytime:

**Rule 3.35**

$$k_{v\_day} = \text{(if (kd}_{calc} < -1) \text{ then } -1 \text{ else if (kd}_{calc} \geq 1) \text{ then } 1 \text{ else kd}_{calc})$$

*where:*

- $k_{v\_day}$  = direction of motion and percentage of max speed used in pursuing the target isolume [dimensionless]
- $kd_{calc}$  = target isolume index [dimensionless]  $-1 \leq kd_{calc} \leq 1$  the value gives the percentage of the maximum speed, the sign gives the direction of migration (negative upwards migration, positive downwards) direction of migration during daytime [dimensionless]

---

### From the literature on diel migration

Observations in Monterey Bay on *L. opalescens* paralarvae show that diel migration starts immediately after hatching (Zeidberg and Hamner, 2002). Hatchlings of *L. pealeii* are found in surface waters day and night. They move deeper as they grow larger (Cargnelli *et al.*, 1999).

Paralarvae are vertically distributed above 80m, with the maximum concentration occurring at 15m during the night and 30m during the day (Okutani and McGowan, 1969; Zeidberg and Hamner, 2002).

## 8. Foraging

Squid migrate to forage at dawn and dusk.

Rule 3.36 computes the effect of satiation on foraging migration:

<p><b>Rule 3.36</b></p> $K_{n\_calc2} = 0.4 (Gut_f - 1)$ <p><i>Where:</i></p> <p>–0.4 &lt; <math>K_{n\_calc2}</math> &lt; 0.8 and depending on how gut fullness</p> <p><math>Gut_f</math> = gut fullness index [dimensionless]</p>
--

Rule 3.37 computes the direction of motion for a squid foraging at night:

<p><b>Rule 3.37</b></p> $K_{v\_night} = ( \text{if } (z > MLDepth) \text{ then } -(0.6) \text{ else } 0.0)$ <p><i>where:</i></p> <p><math>K_{v\_night}</math> = percentage of maximum speed used [dimensionless]</p> <p><math>z</math> = depth [m]</p> <p><math>MLDepth</math> = depth of the turbocline [m]</p> <p>0.6 = routine percentage of maximum speed</p>
---

Rule 3.38 defines the direction of motion of squid:

<p><b>Rule 3.38</b></p> <p>Direction=(if (VisIrradAt(0.0)&lt; 100)then if (<math>K_{v\_night}&gt;0.0</math>) then 1 else –1)else-1)</p> <p><i>where:</i></p> <p>Direction = swimming direction [dimensionless]</p> <p>VisIrradAt(0) = irradiance at surface [<math>Wm^{-2}</math>]</p> <p><math>K_{v\_night}</math> = percentage of maximum speed used [dimensionless]</p> <p>-1 = max speed upward</p> <p>1 = max speed downward</p>
---

## From the literature on foraging

Squids hatch as miniature replicas of the adult and feed in a similar way. Absolute attack speed increases in proportion to mantle length (Chen *et al.*, 1996). After 40 days a squid fed *ad libitum* has a mantle length of about 8 mm,  $ML_{max}$ . La Roe (1971) reported that the squid, even newly hatched fry, were extremely selective in their choice of foods; they would attack and eat only live, actively moving animals of a limited size range. They would not eat dead, inactive, drifting or benthic organisms.

Observations on the foraging strategies were made on Caribbean squid *Sepioteuthis sepioidea* (Moynihan and Rodaniche, 1982). This species mostly rests during the day. Near dusk, the shoaling squid move to shallow water and slowly split up into progressively smaller groups until they are alone throughout the night. They forage and feed until dawn, when they aggregate into shoals.

## 9. Swimming direction

Rule 3.39 defines the direction of swimming for squid pursuing a target isolume:

### Rule 3.39

$$k_v = (\text{if } (\text{visIrradAt}(0) = \text{VIRR}_{\text{prev}}) \text{ then } (\text{if } (\text{visIrradAt}(0.0)=0.0) \text{ then } k_{v\_night} \text{ else } k_{v\_day} ) \text{ else } (\text{if } (\text{visIrradAt}(0.0)> \text{VIRR}_{\text{prev}}) \text{ then } (\text{if } (\text{visIrradAt}(0)<100) \text{ then } k_{v\_night} \text{ else } k_{v\_day} ) \text{ else } (\text{if } (\text{VisIrradAt}(0)<100) \text{ then } k_{v\_night} \text{ else } k_{v\_day} )))$$

where:

$k_v$  = direction of swimming [dimensionless]  
 $k_{v\_day}$  = direction of migration during the day [dimensionless]  
 $k_{v\_night}$  = direction of migration at night [dimensionless]  
 $\text{VIRR}_{\text{prev}}$  = irradiance in previous time step [ $\text{W m}^{-2}$ ]  
 $\text{VisIrradAt}(0)$  = irradiance at surface [ $\text{W m}^{-2}$ ]  
 100 = max irradiance for night foraging [ $\text{W m}^{-2}$ ]

Rule 3.40 defines the irradiance in current time step:

### Rule 3.40

$$\text{VIRR}_{\text{prev}} = \text{VisIrrad}$$

where:

$\text{VIRR}_{\text{prev}}$  = irradiance in previous timestep [ $\text{Wm}^{-2}$ ]  
 $\text{VisIrrad}$  = irradiance in current timestep [ $\text{Wm}^{-2}$ ]

## 10. Motility

Rule 3.41 computes the vertical displacement of a squid:

<i>Rule 3.41</i>	
$V_m = (k_v V_{max} W_z \text{TimeStep})$	
<i>where:</i>	
$V_m$	= vertical displacement [m]
$k_v$	= direction of swimming [dimensionless]
$V_{max}$	= 135 [mh <sup>-1</sup> ] maximum swimming speed
$W_z$	= effect of temperature & size on swimming speed [dimensionless]
TimeStep	= 0.5 [h] timestep

---

### From the literature on motility

Squid paralarvae are defined as plankton; i.e. they cannot swim fast enough to change their local environment by swimming horizontally (Woods, 2002). They are capable of changing their local environment by swimming vertically (Zeidberg and Hamner, 2002). They migrate in the virtual mesocosm at a migration speed which is about 40 % less than the maximum jet speed used to escape attacks (Zeidberg, 2004).

---

## 11. Sinking of corpses

Rule 3.42 computes the vertical displacement of a dead squid:

<i>Rule 3.42</i>	
$V_m = 20\text{TimeStep}$	
<i>where:</i>	
$V_m$	= vertical displacement [m]
TimeStep	= 0.5 [h]
20	= sinking speed of corpses [m h <sup>-1</sup> ]

## 12. Ingestion

Ingestion by squid is based on gut capacity as for copepods see “Part 2. Herbivores”, of this documentation.

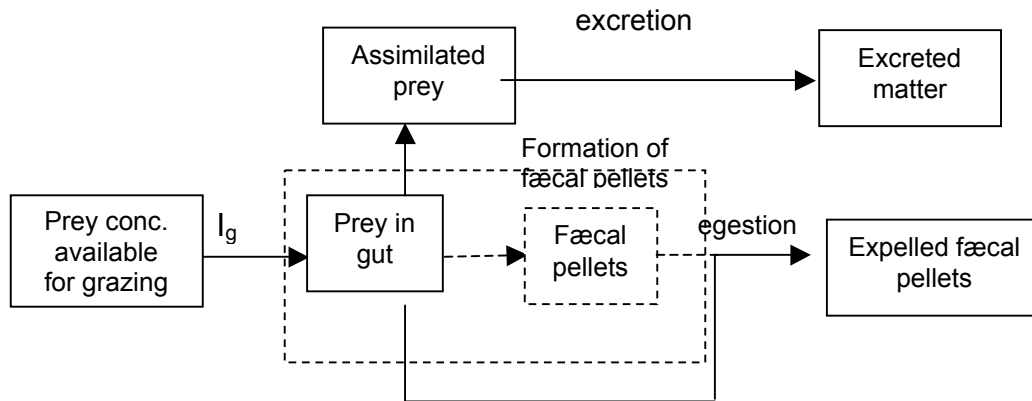

Fig. 3.2 Squid ingestion in LERM

Endogenous and exogenous feeding coexist until the yolk sac is completely absorbed. The post-embryonic squid continue to feed on yolk while beginning to feed on copepods (Vidal *et al.* 2002).

Post-hatching squids feed on all stages of copepods, except for pellets, dead and over-wintering copepods.

Rule 3.43 calculates the number of ingested cells during last timestep:

<b>Rule 3.43</b>	
	$I_{gCells} = \text{varietysum}(\text{IngestedCells})$
<i>where:</i>	
$I_{gCells}$	= number of ingested prey during last timestep [ind]
varietysum	= VEW function (see Handbook)
IngestedCells	= number of prey ingested during last timestep [ind]

Rule 3.44 records the number of ingested prey during squid life-time:

<b>Rule 3.44</b>	
	$\text{CellIng}_{\text{history}} = \text{CellIng}_{\text{history}} + I_{gCells}$
<i>where:</i>	
$\text{CellIng}_{\text{history}}$	= number of ingested prey during squid life-time [ind]
$I_{gCells}$	= number of ingested prey during last timestep [ind]

Rule 3.45 defines the stage specific volume of ingested prey:

<i>Rule 3.45</i>	
	$Prey_{vol} = \text{varietysum} (\text{IngestedCells } P_{vol})$
<i>where:</i>	
$Prey_{vol}$	= volume of ingested prey [mm <sup>3</sup> ]
$\text{IngestedCells}$	= number of stage-specific prey ingested in last timestep [ind]
$P_{vol}$	= stage-specific volume of prey [mm <sup>3</sup> ]

**Gut content** represents the volume of prey in the gut. It increases by feeding and decreases by digestion and egestion. The carapace of copepods is discarded. Rule 3.46 defines the gut content:

<i>Rule 3.46</i>	
	$Gut_{contTemp} = (Gut_{content} + Prey_{vol})$
<i>where:</i>	
$Gut_{contTemp}$	= gut content prior to digestion [mm <sup>3</sup> ]
$Gut_{content}$	= volume of food in gut [mm <sup>3</sup> ]
$Prey_{vol}$	= volume of ingested prey during last timestep [mm <sup>3</sup> ]

Rule 3.47 records the time since last feeding:

<i>Rule 3.47</i>	
	$\text{newLastFeedTime} = (\text{if } (I_{gCells} > 0.0) \text{ then } 0.0 \text{ else } (\text{LastFeedTime} + \text{TimeStep}))$
<i>where:</i>	
$\text{newLastFeedTime}$	= updated hours since last ingestion [h]
$\text{LastFeedTime}$	= hours since last ingestion [h]
$\text{TimeStep}$	= 0.5 [h]

Rule 3.48 updates the time since last feeding to value in the current timestep :

<i>Rule 3.48</i>	
	$\text{LastFeed}_{time} = \text{newLastFeedTime}$
<i>where:</i>	
$\text{newLastFeedTime}$	= updated hours since last ingestion [h]
$\text{LastFeed}_{time}$	= hours since last ingestion [h]

Rule 3.49 defines ingested prey in previous and current timestep :

<i>Rule 3.49</i>	
	$\text{CELLING}_{prev} = I_{gCells}$
<i>where:</i>	
$\text{CELLING}_{prev}$	= prey ingested in previous timestep [ind]
$I_{gCells}$	= prey ingested in current timestep [ind]



## **From the literature on ingestion**

Squid high activity and rapid growth needs a large amount of food and high feeding and digestion efficiency. However, it is impossible to overfeed them (Boucher-Rodoni et al., 1987). The cue to stop feeding when satiated is given by the pressure of food on the stomach walls of an animal. This sends a signal to the hypothalamus announcing that the gut is full. So maximum ingestion rate is modelled as a function of the gut volume that can be filled (i.e. maximum ingestion rate is zero if the gut is already full).

In young cephalopods, as in most adults, attack is elicited by visual stimuli (Boucher-Rodoni et al., 1987). The velocity of the prey, in relation to the swiftness of the predator, affects the efficiency of capture. Planktonic squid are only successful in capturing relatively slow prey such as crustacean larvae and copepods

### 13. Digestion

The time necessary to digest a meal varies from one species of cephalopods to the other, and within the same species it is influenced by temperature. The percentage of digested food as function of time since ingestion is calculated using the empirical regression proposed by Wallace *et al.* (1981).

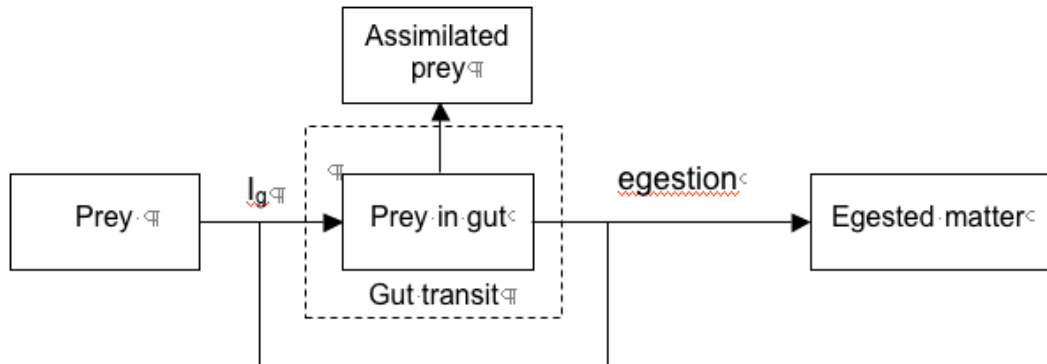

Fig. 3.5 Squid gut processes in LERM

Rule 3.50 (not explicit in the model)

$$\text{Log}_{10} \% \text{ food digested} = 1.64 - 0.032 \text{ LastFeedTime}$$

Where

$$\text{LastFeedTime} = \text{hours since last ingestion [h]}$$

Rule 3.51 defines the percentage in the gut that gets digested,  $\text{Dig}_{\text{perc}}$

Rule 3.51

$$\text{Dig}_{\text{perc}} = \frac{(10^{(1.64 - (0.032 \text{ newLastFeedTime}))})^2 \left( \frac{\text{Temp} - T_{\text{ref}2}}{T_{\text{ref}2}} \right)}{100}$$

Where

- $\text{Dig}_{\text{perc}}$  = percentage of digested food [0-1]
- newLastFeedTime = hours since last ingestion [h]
- 2 = index of digestion increase for 10°C increase from  $T_{\text{ref}2}$
- Temp = ambient temperature [°C]
- $T_{\text{ref}2}$  = 10 [°C] reference temperature

The rate of digestion (volume of food, protein, lipid digested per hour) is a function of temperature, time since last feeding and of the size of meal. Digestion rate doubles with a 10°C increase above the reference temperature (10°C). Rate of digestion is assumed to decrease exponentially with time.

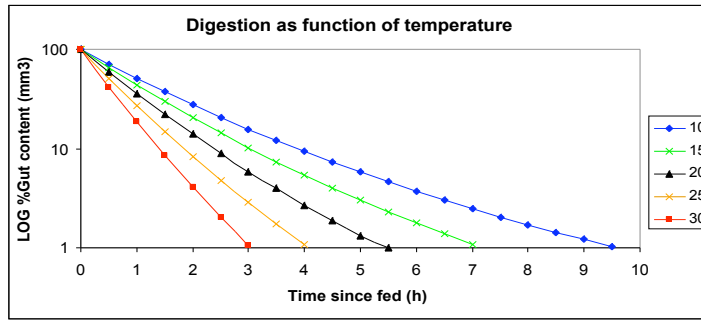

Fig. 3.6 - Digestion rate as a function of temperature and time since feeding.

Rule 3.52 calculates the amount of protein in gut after ingestion:

**Rule 3.52**

$$Gut_{proteinTemp2} = (Gut_{protein} + C_{N\_Ingested})$$

Where

- $Gut_{proteinTemp2}$  = protein in gut after ingestion [mmolC]
- $Gut_{protein}$  = protein in gut at the end of previous timestep [mmolC]
- $C_{N\_Ingested}$  = protein ingested in current timestep [mmolC]

Rule 3.53 calculates the amount of lipid in gut after ingestion:

**Rule 3.53**

$$Gut_{lipidTemp2} = (Gut_{lipid} + C_{NN\_Ingested})$$

Where

- $Gut_{lipidTemp2}$  = lipid in gut after ingestion [mmolC]
- $Gut_{lipid}$  = lipid in gut at the end of timestep [mmolC]
- $C_{NN\_Ingested}$  = lipid ingested in current timestep [mmolC]

Rule 3.54 updates the amount of protein in gut after digestion:

**Rule 3.54**

$$Gut_{protein} = (Gut_{proteinTemp2} - (Gut_{proteinTemp2} Dig_{perc}))$$

Where

- $Gut_{protein}$  = protein in gut at the end of timestep [mmolC]
- $Gut_{proteinTemp2}$  = protein in gut [mmolC]
- $Dig_{perc}$  = percentage of digested food [0-1]

Rule 3.55 updates the amount of lipid in gut after digestion:

**Rule 3.55**

$$Gut_{lipid} = (Gut_{lipidTemp2} - (Gut_{lipidTemp2} Dig_{perc}))$$

Where

- $Gut_{lipid}$  = lipid in gut at the end of timestep [mmolC]
- $Gut_{lipidTemp2}$  = lipid in gut [mmolC]
- $Dig_{perc}$  = percentage of digested food [0-1]

## From literature on digestion

A study on the effect of temperature on digestion duration was carried out for the octopus *Eledone cirrhosa* (Boucher-Rodoni, 1973). The digestion lasted 15 hours at 20°C, 20 hours at 15°C and 30 hours at 10°C (Boucher-Rodoni, 1973).

Karpov and Cailliet (1978) obtained comparable results; they report that *L. opalescens* at 18°C completes the digestion of a meal in about six hours.

Wallace *et al.* (1981) observed that the digestion rate of the squid *Illex illecebrosus*, reared at 10°C, is high soon after feeding, and then slows down gradually.

The rate of food digested represents a fairly constant percentage of the quantity ingested and decreases with time after feeding (Boucher-Rodoni, 1975; Boucher-Rodoni and Mangold, 1977).

## 14. Assimilation

In LERM squid are assumed to assimilate 85% of the digested proteins and 50% of the digested lipids.

Rule 3.56 updates lipid to dry weight ratio:

### Rule 3.56

$$Q_{lip} = (C_{NN\_pool} 12) / DW$$

Where

$Q_{lip}$	= Lipid to dry weight ratio
12	= conversion factor mmol C to mg C [mg C mmolC <sup>-1</sup> ]
$C_{NN\_pool}$	= lipid pool [mmol C]
DW	= dry weight [mg C]

Rule 3.57 computes the assimilated protein:

### Rule 3.57

$$A_{protein} = (((Gut_{protein} + C_{N\_Ingested}) Dig_{perc}) A_{eff\_prot})$$

Where

$A_{protein}$	= protein assimilated [mmol C]
$A_{eff\_prot}$	= 0.85 [dimensionless] protein assimilation efficiency
$C_{N\_Ingested}$	= protein ingested during last timestep [mmol C]
$Dig_{perc}$	= percentage of digested food, it ranges between 0 and 1
$Gut_{protein}$	= protein in gut [mmol C]

Rule 3.58 computes the non-assimilated protein:

### Rule 3.58

$$E_{protein} = (((Gut_{protein} + C_{N\_Ingested}) Dig_{perc}) (1 - A_{eff\_prot}))$$

Where

$E_{protein}$	= protein not assimilated [mmol C]
$A_{eff\_prot}$	= 0.85 [dimensionless] protein assimilation efficiency
$C_{N\_Ingested}$	= protein ingested during last timestep [mmol C]
$Dig_{perc}$	= percentage of digested food, it ranges between 0 and 1
$Gut_{protein}$	= protein in gut [mmol C]

Rule 3.59 computes the assimilated lipid:

**Rule 3.59**

$$A_{lipid} = (if(((Q_{lipMax} - Q_{lip})DW) > ((Gut_{lipid} + C_{NN\_Ingested}) Dig_{perc}) A_{eff_{lip}})) then(((Gut_{lipid} + C_{NN\_Ingested}) Dig_{perc}) A_{eff_{lip}}) else ((Q_{lipMax} - Q_{lip})DW))$$

*Where*

- $A_{lipid}$  = lipid assimilated [mmol C]
- $A_{eff_{lip}}$  = 0.50 [dimensionless] lipid assimilation efficiency
- $C_{NN\_Ingested}$  = lipid ingested during last timestep [mmol C]
- $Dig_{perc}$  = percentage of organic matter digested [dimensionless]
- $DW$  = dry weight [mg C]
- $Gut_{lipid}$  = lipid in gut [mmol C]
- $Q_{lip}$  = lipid to dry weight ratio
- $Q_{lipMax}$  = 0.15 [dimensionless] maximum lipid to dry weight ratio

Rule 3.60 computes the non-assimilated lipid:

**Rule 3.60**

$$E_{lipid} = (((Gut_{lipid} + C_{N\_Ingested}) Dig_{perc}) (1 - A_{eff_{lip}}))$$

*Where*

- $E_{lipid}$  = lipid not assimilated [mmol C]
- $A_{eff_{lip}}$  = 0.50 [dimensionless] lipid assimilation efficiency
- $C_{NN\_Ingested}$  = lipid ingested during last timestep [mmol C]
- $Dig_{perc}$  = percentage of digested food [0-1]
- $Gut_{lipid}$  = lipid in gut [mmol C]

Rule 3.61 defines the test A for lipid into Cal in the timestep

<b>Rule 3.61</b>	
	$TA_{lipid} = (A_{lipid} En_{lip} C_{conv2} )$
<b>Where</b>	
$TA_{lipid}$	= test A for lipid into Cal in timestep [(g mmol)(g mmol) <sup>-1</sup> h <sup>-1</sup> ]
$A_{lipid}$	= assimilated lipid [mmolC h <sup>-1</sup> ]
$En_{lip}$	= energy content of copepod lipid [g C]
$C_{conv2}$	= 0.012 conversion gCarbon mmol Carbon [(g C mmolC) <sup>-1</sup> ]

Rule 3.62 defines the test A for protein into Cal in the timestep

<b>Rule 3.62</b>	
	$TA_{protein} = (A_{protein} En_{prot} C_{conv2} )$
<b>Where</b>	
$TA_{protein}$	= test A for protein into Cal in timestep [(g mmol)(g mmol) <sup>-1</sup> h <sup>-1</sup> ]
$A_{protein}$	= assimilated protein [mmolC h <sup>-1</sup> ]
$En_{protein}$	= energy content of copepod protein [g C]
$C_{conv2}$	= 0.012 conversion gCarbon mmol Carbon [(g C mmolC) <sup>-1</sup> ]

Rule 3.63 defines the total carbon assimilated in the timestep

<b>Rule 3.63</b>	
	$TA_C = (TA_{lipid} + TA_{protein})$
<b>Where</b>	
$TA_C$	= total carbon assimilated in timestep [(g mmol)(g mmol) <sup>-1</sup> h <sup>-1</sup> ]
$TA_{lipid}$	= test A for lipid into Cal in timestep [(g mmol)(g mmol) <sup>-1</sup> h <sup>-1</sup> ]
$TA_{protein}$	= test A for protein into Cal in timestep [(g mmol)(g mmol) <sup>-1</sup> h <sup>-1</sup> ]

---

### From the literature on assimilated carbon

O'Dor *at al.* (1984), Lee (1994), Wells and Clarke (1996) report that squid assimilation efficiency for proteins is very high (81-92%), while assimilation efficiency for lipids is much lower (50%). According to O'Dor and Wells (1987) and Wells and Clarke (1996), a large part of lipid (45-70%) passes through the digestive tract and floats as fæces.

## 15. Gut volume

A recently hatched squid (ML= ~ 2.8 mm, Carbon pool = 0.07 mmol C) has a gut volume of 0.6 mm<sup>3</sup>. It can potentially ingest about 90 C1 copepods (individual volume: 6.4 x 10<sup>-3</sup> mm<sup>3</sup>; carbon content: 6.3 x 10<sup>-5</sup> mmol C ), therefore ingesting ~ 9.5% body weight.

Rule 3.64 defines the gut volume:

### Rule 3.64

$$V_{\text{gut}} = \max ((v_{\text{gut}} \text{ ML}), V_{\text{gut}})$$

Where

$V_{\text{gut}}$  = gut volume [mm<sup>3</sup>]

$v_{\text{gut}}$  = stomach volume coefficient [mm<sup>2</sup>]

ML = mantle length [mm]

---

### From the literature on gut volume

Experimental data on squid paralarvae meals showed it ranged from 5-15% DW meal/DW body (Boucher-Rodoni, 1975; Wallace O'Dor 1981, Hirtle *et al.*, 1981). The stomach weight grows as function of body size (Hurley 1976).



## 16. Respiration: basal metabolic cost

Respiration is a heterogeneous process, whose separate components vary independently (Wells and Clarke, 1996).

The respiration costs are associated with:

- maintenance (basal metabolism),
- new somatic tissues, feeding, digestion and assimilation, Specific Dynamic Action (SDA),
- movement.

The respiration rate [ $\text{mmolC h}^{-1}$ ], is the sum of the three components.

Basal respiration is a function of the size of the squid and temperature. O'Dor *et al.* (1986) propose a rule for *L. opalescens*:  $R_{\text{bas}} = BA^{\text{Temp}} E_{\text{conv}}$  [ $\text{ml O}_2 \text{ kg}^{-1} \text{h}^{-1}$ ].

Rule 3.64 is based on the aforementioned rule:

### Rule 3.64

$$R_{\text{bas}} = \left( \frac{WW}{1 \times 10^6} B A^{\text{Temp}} E_{\text{conv}} \right)$$

where:

- $R_{\text{bas}}$  = basal metabolic cost [ $\text{cal h}^{-1}$ ]
- A = 1.0879 [dimensionless] respiration parameter
- B = 123.7 [dimensionless] respiration parameter
- $E_{\text{conv}}$  = 4.6 [ $\text{cal mlO}_2^{-1}$ ]  $\text{mlO}_2$  to cal conversion factor
- Temp = ambient temperature [ $^{\circ}\text{C}$ ]
- WW = Wet weight [mg]

### 17. Respiration: specific dynamic action cost

Rule 3.65 computes the cost associated with Specific Dynamic Action  $R_{sda}$ , proportional to the energy of lipid and protein assimilated (Perry, 1983):

**Rule 3.65**

$$R_{sda} = \frac{(r_{sda} ((A_{lipid} C_{conv2} En_{lip}) + (A_{protein} C_{conv2} En_{prot})))}{TimeStep}$$

where:

- $R_{sda}$  = cost of somatic growth [ $cal\ h^{-1}$ ]
- $A_{lipid}$  = lipid assimilated in last timestep [mmol C]
- $A_{protein}$  = protein assimilated in last timestep [mmol C]
- $C_{conv2}$  = 0.012 [ $gC\ mmol\ C^{-1}$ ] gC to mmol C conversion factor [ $gC\ mmolC^{-1}$ ]
- $En_{lip}$  = 9000 [ $cal\ gC^{-1}$ ] energy content of squid lipid
- $En_{prot}$  = 5700 [ $cal\ gC^{-1}$ ] energy content of squid protein
- $r_{sda}$  = 0.2 [dimensionless] cost of somatic growth parameter

### 18. Respiration: cost of swimming

Swimming cost is a function of the animal size, swimming speed and water density (O'Dor *et al.*, 1986). Cost associated with swimming is estimated using the calculations for the locomotion energetic cost for hatchling squid, *Illex illecebrosus* (O'Dor *et al.*, 1986):

Rule 3.66 calculates the swimming speed:

**Rule 3.66**

$$U = |k_v| V_{\max}$$

where:

- U = swimming speed [mh<sup>-1</sup>]
- V<sub>max</sub> = 135 [mh<sup>-1</sup>] maximum swimming speed
- k<sub>v</sub> = percentage of maximum speed used for movement [dimensionless]

Rule 3.67 calculates the Reynold's number R<sub>e</sub>:

**Rule 3.67**

$$R_e = \frac{\left( \frac{ML}{1000} \frac{U}{3600} \right)}{\nu}$$

where:

- R<sub>e</sub> = Reynold's number [dimensionless]
- U = swimming speed [mh<sup>-1</sup>]
- ML = mantle length [mm]
- ν = 10<sup>-6</sup> [m<sup>2</sup>s<sup>-1</sup>] coefficient of kinematic viscosity

Rule 3.68 calculates the drag coefficient C<sub>d</sub>:

**Rule 3.68**

$$C_d = \left( \text{if } (Re > 0.0) \text{ then } \frac{24}{Re^{0.7}} \text{ else } 0.0 \right)$$

where:

- C<sub>d</sub> = drag coefficient [dimensionless]
- Re = Reynold's number [dimensionless]

Rule 3.69 calculates the drag force D:

**Rule 3.69**

$$D = (0.5 C_d (\text{Density} + 1000) S \frac{U}{3600})^2$$

where:

- D = drag force [kg m s<sup>-2</sup>]
- C<sub>d</sub> = drag coefficient [dimensionless]
- (Density+1000) = density of the water [kg m<sup>-3</sup>]
- S = frontal surface area [m<sup>2</sup>]
- (U/3600) = swimming speed [m s<sup>-1</sup>]

Rule 3.70 calculates the power consumption P<sub>w</sub>:

**Rule 3.70**

$$P_w = D (U/3600)$$

where:

- P<sub>w</sub> = power consumption [kg m<sup>2</sup> s<sup>-3</sup>]
- D = drag force [kg m s<sup>-2</sup>]
- (U/3600) = swimming velocity [ms<sup>-1</sup>]

Rule 3.71 transforms P from [W] to [cal d<sup>-1</sup>] using the conversion 1 W = 20,635 cal d<sup>-1</sup> (O'Dor *et al.*, 1986)

**Rule 3.71**

$$R_{\text{swim}} = P_w (E_{\text{conv}2}/24)$$

where:

- R<sub>swim</sub> = cost of swimming at speed U [cal h<sup>-1</sup>]
- P<sub>w</sub> = power consumption [kg m<sup>2</sup> s<sup>-3</sup>]
- E<sub>conv2</sub> = 20635 [cal W<sup>-1</sup> d<sup>-1</sup>] W to cal per day conversion factor
- (E<sub>conv2</sub>/24) = 860 [cal W<sup>-1</sup> h<sup>-1</sup>] W to cal per hour conversion factor

## From the literature on respiration

Respiration is a heterogeneous process, whose separate components basal metabolism, specific dynamic action, and activity metabolism vary independently (Wells and Clarke, 1996). The basal metabolic cost is weight-specific and temperature-dependent. For *L. opalescens*, is  $R_{\text{bas}} = B(A)^T$  (O'Dor *et al.*, 1986). SDA is proportional to the energy of lipid and protein assimilated (Perry, 1983). Swimming cost is a function of the animal size, swimming speed and water density O'Door *et al.*, 1986

Yolk provides the energy for metabolism until its complete exhaustion. If the yolk energy is not sufficient then the surplus costs are covered by lipids, preferentially, or proteins. (Bouchaud and Galois, 1990; Vidal *et al.*, 2002).

When the yolk sac is completely exhausted, lipids are used preferentially to cover metabolic costs over proteins (Wells and Clarke, 1996).

---

### *Parameters values in the literature*

A	= 1.0879 [dimensionless]	respiration parameter From O'Door <i>et al.</i> (1986)
B	= 123.9 [dimensionless]	respiration parameter From O'Dor <i>et al.</i> (1986)

## 19. Energetics

During the first few days after hatching metabolic costs are covered by the energy provided by the yolk.

Rule 3.72 defines the respiration rate:

<b>Rule 3.72</b>	
	$\text{respiration} = (R_{\text{bas}} + R_{\text{sda}} + R_{\text{swim}})$
<i>where:</i>	
respiration	= respiration rate [ $\text{cal h}^{-1}$ ]
$R_{\text{bas}}$	= respiration rate due to basal metabolism [ $\text{cal h}^{-1}$ ]
$R_{\text{sda}}$	= respiration rate due to specific dynamic action [ $\text{cal h}^{-1}$ ]
$R_{\text{swim}}$	= respiration rate due to motion [ $\text{cal h}^{-1}$ ]

Rule 3.73 resets the number of hours elapsed in the day (used to compute the daily percentage of body weight ingested):

<b>Rule 3.73</b>	
	$\text{ClockTemp} = (\text{if } (\text{Clock} < 24) \text{ then } (\text{Clock} + \text{TimeStep}) \text{ else } 0)$
<i>where:</i>	
ClockTemp	= updated hour [h]
Clock	= hour [h]
TimeStep	= 0.5 [h]

Rule 3.74 updates the hours passed in the day before the current timestep:

<b>Rule 3.74</b>	
	$\text{Clock} = \text{ClockTemp}$
<i>where:</i>	
ClockTemp	= updated hour [h]
Clock	= hour [h]

Rule 3.75 records the number of prey ingested during a day:

<b>Rule 3.75</b>	
	$\text{IG}_{\text{daily}} = (\text{if } (\text{ClockTemp} < 24) \text{ then } (\text{IG}_{\text{daily}} + \text{I}_{\text{gCells}}) \text{ else } 0.0)$
<i>where:</i>	
$\text{IG}_{\text{daily}}$	= number of prey ingested per day [ind]
Clock	= hour [h]
$\text{I}_{\text{gCells}}$	= of prey ingested per timestep [ind]

Rule 3.76 records the carbon ingested during a day:

**Rule 3.76**

$$\text{Cing}_{\text{daily}} = (\text{if} (\text{ClockTemp} < 24) \text{ then } (\text{Cing}_{\text{daily}} + \text{Carbon}_{\text{Ingested}}) \text{ else } 0.0)$$

*where:*

$\text{Cing}_{\text{daily}}$  = carbon ingested per day [mmolC]  
 $\text{ClockTemp}$  = hour [h]  
 $\text{Carbon}_{\text{Ingested}}$  = Carbon ingested per timestep [mmolC]

Rule 3.77 calculates the ratio carbon ingested during a day against the carbon pool:

**Rule 3.77**

$$\text{Cratio}_{\text{daily}} = (\text{if} (\text{ClockTemp} < 24) \text{ then } 0.0 \text{ else } \frac{(\text{Cing}_{\text{daily}} + \text{Carbon}_{\text{Ingested}})}{\text{Carbon}_{\text{Pool}}})$$

*where:*

$\text{Cratio}_{\text{daily}}$  = ratio of carbon ingested to carbon pool [mmolC molC<sup>-1</sup>]  
 $\text{Cing}_{\text{daily}}$  = carbon ingested per day [mmolC]  
 $\text{ClockTemp}$  = hour [h]  
 $\text{Carbon}_{\text{Ingested}}$  = Carbon ingested per timestep [mmolC]

Rule 3.78 records number of sub-optimal feeding (<10% of Carbon<sub>Pool</sub>):

**Rule 3.78**

$$\text{Days}_{\text{unfed}} = (\text{if} (\text{ClockTemp} = 24) \text{ then } (\text{if} (\text{Cratio}_{\text{daily}} < 0.1) \text{ then } (\text{Days}_{\text{unfed}} + 1) \text{ else } 0.0) \text{ else } \text{Days}_{\text{unfed}})$$

*where:*

$\text{Days}_{\text{unfed}}$  = number of days of sub-optimal feeding  
 $\text{Cratio}_{\text{daily}}$  = ratio of carbon ingested to carbon pool [mmolC molC<sup>-1</sup>]  
 $\text{ClockTemp}$  = hour [h]

## 20. Update gut content

Rule 3.79 computes the volume of food digested:

### Rule 3.79

$$\text{Processed} = (\text{Gut}_{\text{content}} \text{ Dig}_{\text{perc}})$$

Where:

Processed = volume of food digested [mm<sup>3</sup>]

Gut<sub>content</sub> = Gut content [mm<sup>3</sup>]

Dig<sub>perc</sub> = percentage of digested food, range 0 -1 [dimensionless]

Rule 3.80 computes the gut content after digestion:

### Rule 3.80

$$\text{Gut}_{\text{content}} = (\text{Gut}_{\text{contTemp}} - \text{Processed})$$

Where:

Gut<sub>content</sub> = Gut content [mm<sup>3</sup>]

Gut<sub>contTemp</sub> = Gut content at the beginning of the timestep [mm<sup>3</sup>]

Processed = volume of food digested in current timestep [mm<sup>3</sup>]

Rule 3.81 calculates the gut fullness:

### Rule 3.81

$$\text{Gut}_{\text{fTemp}} = \text{Gut}_{\text{contTemp}} / V_{\text{gut}}$$

Where:

Gut<sub>fTemp</sub> = gut fullness index [dimensionless] 0 = empty gut; 1 = full gut

Gut<sub>contTemp</sub> = gut content at the beginning of the timestep [mm<sup>3</sup>]

V<sub>gut</sub> = gut volume [mm<sup>3</sup>]

**Efficiency of prey capture.** Mastery of copepod capture is a skill acquired in early in post-hatching life and is a function of ML. The speed of the prey is another factor affecting the efficiency of capture, in relation to the speed of the predator. In LERM, hunting efficiency is modelled as a function of the ratio of squid ML and the stage-specific copepod maximum swimming speed.

Rule 3.82 defines the hunting efficiency:

### Rule 3.82

$$\text{Hunting}_{\text{effIndex}} = \text{ML} / \text{ML}_{\text{max}}$$

Where

Hunting<sub>effIndex</sub> = hunting efficiency index [dimensionless]

ML = mantle length [mm]

ML<sub>max</sub> = 8 [mm] maximum mantle length



Rule 3.83 defines the maximum ingestion rate:

**Rule 3.83**

$$I_{\max} = \left( \text{if } (z < 500) \text{ then } \max \left( 0.0, \frac{((1 - \min(\text{Gut}_{\text{Temp}}, 1))V_{\text{gut}})}{1} \right) \text{ else } 5 \times 10^{-4} \right) \frac{1}{(3600 \text{TimeStep})}$$

Where

- $I_{\max}$  = maximum ingestion rate [ $\text{mm}^3 \text{s}^{-1}$ ]
- $\text{Gut}_{\text{Temp}}$  = gut fullness index [dimensionless] 0: empty gut; 1: full gut
- $V_{\text{gut}}$  = gut volume [ $\text{mm}^3$ ]
- $z$  = depth [m]
- TimeStep = 0.5 [h]

**Size specific ingestion.** Post-hatching squids feed on all stages of copepods, except dead and over-wintering copepods, and pellets. Ingestion rate is a function of prey visibility (size and ambient irradiance), predator hunting efficiency, prey stage specific speed of escape, prey concentration, squid gut volume and gut fullness.

Rule 3.84 defines the stage specific ingestion rate:

**Rule 3.84**

$I_{\text{gv}} =$

$$\text{integrate}(\left( \text{if}((P > P_{\min}) \text{ and } (\text{Gut}_{\text{Temp}} \leq 1)) \text{ then } \min\left( K_p \frac{P_{\text{size}} \text{ Vis}_{\text{Irrad}}}{1.3 \times 10^{-7} \text{ Vis}_{\text{IrradRef}}}, \text{Hunting}_{\text{effIndex}} \frac{((P - P_{\min})P_{\text{vol}})^2}{((P - P_{\min})P_{\text{vol}}) + (k_{\text{iv}}P_{\text{vol}})} \frac{45}{P_{\text{speed}}} (1 - \text{Gut}_{\text{Temp}}), I_{\max} \right) \text{ else } 0 \right) \text{ if } (z \approx z[1]) \text{ then } |z - z[1]| \text{ else } 1)$$

Where

- $I_{\text{gv}}$  = stage specific ingestion rate [ $\text{mm}^3 \text{s}^{-1}$ ]
- $\text{Gut}_{\text{Temp}}$  = gut fullness index [dimensionless] 0 = empty gut; 1 = full gut
- $\text{Hunting}_{\text{effIndex}}$  = hunting efficiency index [dimensionless]
- $I_{\max}$  = maximum ingestion rate [ $\text{mm}^3 \text{s}^{-1}$ ]
- $k_{\text{iv}}$  = half-saturation constant [prey  $\text{m}^{-3}$ ]
- $k_p$  = predator volume scan rate [ $\text{m}^3 \text{s}^{-1}$ ]
- $P$  = stage specific ambient prey concentration [prey  $\text{m}^{-3}$ ]
- $P_{\min}$  = stage specific minimum ambient prey concentration [prey  $\text{m}^{-3}$ ]
- $P_{\text{size}}$  = copepod stage specific surface area [ $\text{m}^2$ ]
- $P_{\text{sizeMax}}$  =  $1.3 \times 10^{-7}$  [ $\text{m}^2$ ] maximum surface area for an adult
- $P_{\text{speed}}$  = stage specific maximum swimming speed [ $\text{m h}^{-1}$ ]
- $P_{\text{speedMax}}$  = 4.5 maximum swimming speed for an adult copepod [ $\text{m h}^{-1}$ ]
- $P_{\text{vol}}$  = stage specific prey volume [ $\text{mm}^3$ ]
- $\text{Vis}_{\text{Irrad}}$  = ambient irradiance [ $\text{W m}^{-2}$ ]
- $\text{Vis}_{\text{IrradRef}}$  = 1 [ $\text{W m}^{-2}$ ] reference irradiance
- $z$  = current depth [m]
- $z[1]$  = depth in previous timestep [m]

Rule 3.85 defines the total potential ingestion rate:

<b>Rule 3.85</b>	
$\text{Totl}_{\text{gv}} = \text{varietysum} (I_{\text{gv}})$	
<i>Where</i>	
$\text{Totl}_{\text{gv}}$	= total potential volume [ $\text{mm}^3 \text{ s}^{-1}$ ]
Varietysum= sum of the volume for each prey stage (VEW function, see Handbook)	
$I_{\text{gv}}$	= stage specific ingestion rate [ $\text{mm}^3 \text{ s}^{-1}$ ]

If the potential volume available for ingestion is bigger than the volume that can be ingested, then the request is scaled down to avoid overfeeding. Rule 3.86 defines the ratio between maximum ingestion rate and the total volume available for ingestion:

<b>Rule 3.86</b>	
$\text{ratioIn} = \left( \text{if } (\text{Totl}_{\text{gv}} > I_{\text{max}}) \text{ then } \frac{I_{\text{max}}}{\text{Totl}_{\text{gv}}} \text{ else } 1 \right)$	
<i>Where</i>	
$\text{ratioIn}$	= ratio max ingestable / available volume [ $(\text{mm}^3 \text{ s}^{-1}) (\text{mm}^3 \text{ s}^{-1})^{-1}$ ]
$\text{Totl}_{\text{gv}}$	= total potential volume [ $\text{mm}^3 \text{ s}^{-1}$ ]
$I_{\text{max}}$	= maximum ingestion rate [ $\text{mm}^3 \text{ s}^{-1}$ ]

Rule 3.87 defines the stage specific effective ingestion rate:

<b>Rule 3.87</b>	
$I_{\text{gv}2} = \left( \frac{I_{\text{gv}}}{P_{\text{vol}}} \text{ratioIn} \right)$	
<i>Where</i>	
$I_{\text{gv}2}$	= stage specific effective ingestion rate [ $\text{ind s}^{-1}$ ]
$I_{\text{gv}}$	= stage specific ingestion rate [ $\text{mm}^3 \text{ s}^{-1}$ ]
$P_{\text{vol}}$	= stage specific prey volume for each individual [ $\text{mm}^3$ ]
$\text{ratioIn}$	= ratio max ingestable / available volume [ $(\text{mm}^3 \text{ s}^{-1}) (\text{mm}^3 \text{ s}^{-1})^{-1}$ ]

Rule 3.88 defines the ingestion request for each prey stage:

<b>Rule 3.88</b>	
$\text{ingest} (P, P_{\text{min}}, I_{\text{gv}2})$	
<i>Where</i>	
$I_{\text{gv}2}$	= stage specific effective ingestion rate [ $\text{mm}^3 \text{ s}^{-1}$ ]
$P$	= stage specific ambient prey concentration [ $\text{prey m}^{-3}$ ]
$P_{\text{min}}$	= 200 minimum ambient prey concentration [ $\text{prey m}^{-3}$ ]

Rule 3.89 updates the gut fullness index:

<b>Rule 3.89</b>	
$\text{Gut}_f = \text{Gut}_{f\text{Temp}}$	
<i>Where</i>	
$\text{Gut}_f$	= gut fullness index [dimensionless] 0 = empty gut; 1 = full gut
$\text{Gut}_{f\text{Temp}}$	= gut fullness index [dimensionless]

## **From the literature**

### **Ingestion rate**

Squid high activity and rapid growth needs a large amount of food and high feeding and digestion efficiency. However, it is impossible to overfeed them (Boucher-Rodoni et al., 1987). The cue to stop feeding when satiated is given by the pressure of food on the stomach walls of an animal. This sends a signal to the hypothalamus announcing that the gut is full. So maximum ingestion rate is modelled as a function of the gut volume that can be filled (i.e. maximum ingestion rate is zero if the gut is already full).

In young cephalopods, as in most adults, attack is elicited by visual stimuli (Boucher-Rodoni et al., 1987). The velocity of the prey is another factor affecting the efficiency of capture, in relation to the swiftness of the predator. Planktonic squid are only successful in capturing relatively slow prey such as crustacean larvae and copepods

## 21. Depth of egg mass

Rule 3.90 set the depth at which eggs are laid:

### Rule 3.90

$$Z = Z_{\text{egg}}$$

Where

$Z$	= depth [m]
$Z_{\text{egg}}$	= 50 [m] depth at which eggs are laid

## 22. Update depth

Rule 3.91 updated the depth of a squid (alive or dead):

### Rule 3.91

$$Z_{\text{temp}} = \max((\text{if } (z \leq \text{MLDepth}) \text{ then if } (\text{visIrrradAt}(0.0) \geq 100) \text{ min } ((\text{rnd}(\text{MLDepth}) + V_m), \text{Depth}_{\text{It}}) \text{ else } (\text{rnd}(\text{MLDepth}) + V_m)) \text{ else } (z + V_m)), 0.0)$$

Where

$Z_{\text{temp}}$	= depth in current timestep [m]
$\text{Depth}_{\text{It}}$	= depth of target isolume [m]
$\text{MLDepth}$	= depth of the turbocline [m]
$\text{rnd}$	= function of the VEW see Handbook range (0 – $\text{MLDepth}$ )
$\text{VisIrrradAt}(0)$	= irradiance at surface [ $\text{Wm}^{-2}$ ]
$V_m$	= vertical displacement [m]
$z$	= depth in at the end of previous timestep [m]

A recruited squid exits the virtual ecosystem. Rule 3.92 updates the depth of a recruit to 450 m:

### Rule 3.92

$$z = (\text{if } (\text{ML} < \text{ML}_{\text{max}}) \text{ then } z_{\text{temp}} \text{ else } 450)$$

where:

$z$	= depth in at the end of timestep [m]
$\text{ML}$	= mantle length [mm]
$\text{ML}_{\text{Max}}$	= 8 [mm] mantle length for recruitment
$Z_{\text{temp}}$	= depth in current timestep [m]

## 23. Hatching

The squid intra-population variability in hatching date is modelled in LERM as a variation of the initial daily accumulated temperature (DAT) and justified as a consequence of the variation in egg size.

In LERM-ES eggs hatch when DAT is  $600^{\circ}\text{DAT}(\text{DAT}_{\text{hatch}})$ .

Rule 3.93 updates the depth of the squid (a recruited squid is inactive and its depth is set to 450 m):

**Rule 3.93**

if  $(\text{DAT} \geq \text{DAT}_{\text{hatch}})$  and  $(\text{Vis}_{\text{Irrad}} = 0.0)$ , change (Hachling)

where:

$\text{DAT}$  = daily accumulated temperature [ $^{\circ}\text{C days}$ ]

$\text{DAT}_{\text{hatch}}$  = **600 [ $^{\circ}\text{C days}$ ] daily accumulated temperature]**

$\text{Vis}_{\text{Irrad}}$  = ambient irradiance [ $\text{Wm}^{-2}$ ]

change = VEW metamorphosis function (see Handbook)

---

### From the literature on hatching

The duration of cephalopod embryogenesis depends mainly on egg size and ambient temperature (Laptikhovsky, 1991). In *L. opalescens* and *L. forbesi*, it the last paralarva hatches 4-6 and 7 days, respectively, after the first one (Yang et al., 1986; Segawa et al., 1988; Arkhipkin and Middleton, 2003).

The shortest embryonic period for squid was observed for *L. pealeii* with small eggs developing in warm water (10 days at  $23^{\circ}\text{C}$ ); the longest developmental period was recorded in the temperate *L. forbesi* with large eggs (130 days at  $8^{\circ}\text{C}$ ) as reported by Craig, Boyle, Black and Overnell (2000).

Baron (2000) incubated *L. gahi* eggs at temperatures varying between  $4^{\circ}\text{C}$  and  $23^{\circ}\text{C}$ , and found that full embryogenesis requires from 600 to 850 daily accumulated temperature ( $\text{DAT} \equiv ^{\circ}\text{C days}$  Baron (2000)).

## 24. Update yolk pool

**Endogenous feeding.** The energy provided by the yolk covers all respiration costs until its complete exhaustion. If the yolk energy is not sufficient, then the surplus cost ( $R_{\text{surplus}}$ ) is covered preferentially by body lipid, or if by body protein.

Rule 3.94 defines the role of yolk in respiration (from Bouchaud and Galois, 1990; Vidal *et al.*, 2002):

### Rule 3.94

$$\text{Yolk}_{\text{lipids}} = (\text{if } (\text{Yolk}_{\text{lipids}} > 0.0)) \text{ then } (\text{if } ((\text{Yolk}_{\text{lipids}} - (\text{respiration TimeStep}) \geq 0.0) \text{ then } (\text{Yolk}_{\text{lipids}} - (\text{respiration TimeStep})) \text{ else } 0.0) \text{ else } 0.0)$$

Where

respiration = energy consumption rate [cal h<sup>-1</sup>]  
 Yolk<sub>lipids</sub> = energy in yolk [cal]  
 TimeStep = 0.5 [h]

Rule 3.95 computes the excess costs not covered by yolk:

### Rule 3.95

$$R_{\text{surplus}} = (\text{if } (\text{Yolk}_{\text{lipids}} > 0.0) \text{ then } \text{if } (\text{Yolk}_{\text{lipids}} - (\text{respiration TimeStep}) < 0.0) \text{ then } ((\text{respiration TimeStep}) - \text{Yolk}_{\text{lipids}}) \text{ else } 0.0) \text{ else } 0.0)$$

Where

$R_{\text{surplus}}$  = energetic consumption rate not covered by yolk energy [cal mg<sup>-1</sup>]  
 Yolk<sub>lipids</sub> = energy in yolk [cal]  
 respiration = energy consumption rate [cal h<sup>-1</sup>]  
 TimeStep = 0.5 [h]

## 25. Update lipid

The flux of body lipid ( $Budg_{CNN}$ ) results from the difference between energy gained for lipid ( $A_{lipid}$ ) and assimilated, and the total respiration cost.

Rule 3.96 computes the flux of body lipid in the current timestep  $Budg_{CNNTemp}$ .

### Rule 3.96

$$Budg_{CNNTemp} = (0.0 + A_{lipid} - \frac{((\text{respiration TimeStep}) + R_{surplus})}{(E_{lip} C_{conv2})} (1 - Q_{Plused})))$$

Where

$Budg_{CNNTemp}$	= flux of body lipid [mmol C]
$A_{lipid}$	= Lipid assimilated in last timestep [mmol C]
$C_{conv2}$	= 0.012 [gC mmol C <sup>-1</sup> ] gC to mmol C conversion factor
$E_{lip}$	= Energy content of squid lipid [cal gC <sup>-1</sup> ]
$Q_{Plused}$	= Ratio of protein to lipid captabolism [dimensionless]
respiration	= total metabolic cost [cal h <sup>-1</sup> ]
$R_{surplus}$	= cost not covered by the yolk [mmol C]
TimeStep	= 0.5 [h]

Rule 3.97 defines the lipid over maximum ratio  $Lip_{excess}$

### Rule 3.97

$$Lip_{excess} = \left( \text{if} \left( \frac{((C_{NN\_Pool} + Budg_{CNNTemp})12)}{DW} > Q_{lipMax} \right) \right. \\ \left. \text{then} \left( \left( \frac{((C_{NN\_Pool} + Budg_{CNNTemp})12)}{DW} - Q_{lipMax} \right) DW \right) \text{ else } 0.0 \right)$$

Where

$Lip_{excess}$	= lipid above the maximum lipid pool to DW ratio [dimensionless]
12	= $C_{conv}$ [mg C mmol C <sup>-1</sup> ] mmol C to mg C conversion
$Budg_{CNN}$	= flux of body lipid after removal of excess lipid [mmol C]
$C_{NN\_Pool}$	= lipid pool [mmol C]
DW	= Dry weight [mgC]
$Q_{lipMax}$	= 0.15 [dimensionless] maximum ratio of lipids to DW

Rule 3.98 updates the flux of body lipid  $Budg_{CNN}$  after removal of excess lipid:

**Rule 3.98**

$$Budg_{CNN} = (\text{if}(\text{Lip}_{\text{excess}} > 0.0) \text{ then } (Budg_{CNN_{Temp}} - \text{Lip}_{\text{excess}}) \text{ else } Budg_{CNN_{Temp}})$$

*Where*

- $Budg_{CNN}$  = flux of body lipid after removal of excess lipid [mmol C]
- $Lip_{\text{excess}}$  = lipid exceeding maximum ratio lipid pool / DW [dimensionless]
- $Budg_{CNN_{Temp}}$  = flux of body lipid [mmol C]

Rule 3.99 updates the lipid pool:

**Rule 3.99**

$$C_{NN\_Pool} = \max((C_{NN\_Pool} + (\text{if}(|Budg_{CNN}| < C_{NN\_Pool} \text{ or } (Budg_{CNN} > 0.0)) \text{ then } Budg_{CNN} \text{ else } 0.0)), 0.0)$$

*Where*

- $C_{NN\_Pool}$  = lipid pool [mmol C]
- $Budg_{CNN}$  = flux of body lipid after removal of excess lipid [mmol C]

Rule 3.100 updates the lipid to protein ratio:

**Rule 3.100**

$$Q_{pl} = (\text{if} (C_{NN\_Pool} > 0.0) \text{ then } \frac{C_{N\_Pool}}{C_{NN\_Pool}} \text{ else } 0.0)$$

*Where*

- $Q_{pl}$  = protein / lipid body ratio [mmol C mmol C<sup>-1</sup>]
- $C_{NN\_Pool}$  = lipid pool [mmol C]
- $C_{N\_Pool}$  = protein pool [mmol C]



## 26. Update protein

The flux of body protein ( $Budg_{CN}$ ) results from the difference between energy gained for protein ( $A_{protein}$ ) and assimilated and the total respiration cost.

Rule 3.101 computes the flux of body protein  $Budg_{CN}$ :

### Rule 3.101

$$Budg_{CN} = (0.0 + A_{protein} - \left( \frac{((respiration \ TimeStep) + R_{surplus})}{(En_{prot} \ C_{conv2})} \right) \text{ (if } (Budg_{CNN} < 0.0) \text{ and } (C_{NN\_Pool}) < |Budg_{CNN}| \text{)) then } 1 \text{ else } Q_{PLused} \text{))}$$

Where

- $Budg_{CN}$  = flux of body protein [mmol C]
- $A_{protein}$  = protein assimilated [mmol C h<sup>-1</sup>]
- $Budg_{CNN}$  = flux of body lipid after removal of excess lipid [mmol C]
- $C_{conv2}$  = 0.012 [gC mmol C<sup>-1</sup>] gC to mmol C conversion factor
- $C_{NNpool}$  = Lipid pool [mmol C]
- $En_{protein}$  = 5700 [cal gC<sub>N</sub>] energy content of squid protein
- $Q_{PL\_used}$  = 0 [dimensionless] proportion of protein-lipid used for metabolism
- respiration = total metabolic cost [cal h<sup>-1</sup>]
- $R_{surplus}$  = cost not covered by the yolk [mmol C h<sup>-1</sup>]
- TimeStep = 0.5 [h]

Rule 3.102 computes the protein pool:

### Rule 3.102

$$Protein_{PoolTemp} = (C_{N\_Pool} + Budg_{CN})$$

Where

- $Protein_{PoolTemp}$  = protein pool [mmol C]
- $Budg_{CN}$  = flux of body protein [mmol C]
- $C_{N\_Pool}$  = protein pool at the end of previous timestep [mmol C]

Rule 3.103 updates the protein pool:

### Rule 3.104

$$C_{N\_Pool} = Protein_{PoolTemp}$$

Where

- $Protein_{PoolTemp}$  = Protein pool [mmol C]
- $C_{Npool}$  = Protein pool at the end of timestep [mmol C]

## 27. Total carbon

Rule 3.105 updates the carbon pool:

*Rule 3.105*

$$\text{Carbon}_{\text{pool}} = (\text{C}_{\text{N\_Pool}} + \text{C}_{\text{NN\_Pool}})$$

Where

$\text{Carbon}_{\text{pool}}$	= carbon pool [mmol C]
$\text{C}_{\text{N\_Pool}}$	= protein pool [mmol C]
$\text{C}_{\text{NN\_Pool}}$	= lipid pool [mmol C]

---

## 28. Weight

Rule 3.106 updates the dry weight:

*Rule 3.106*

$$\text{DW} = (\text{Carbon}_{\text{pool}} \cdot 12)$$

Where

DW	= Dry weight [mgC]
$\text{Carbon}_{\text{pool}}$	= carbon pool [mmol C]
12	= $\text{C}_{\text{conv}}$ [mg C mmol C <sup>-1</sup> ] mmol C to mg C conversion

The dry weight is correlated to wet weight using the lab experiments reported in Vidal *et al.* (2002).

Rule 3.107 updates the wet weight:

*Rule 3.107*

$$\text{WW} = \frac{(\text{DW} - 0.064)}{0.21}$$

Where

WW	= Wet weight [mgC]
DW	= Dry weight [mgC]

## 29. Mantle length

Rule 3.108 updates the mantle length (Hurley, 1976):

### Rule 3.108

$$ML = (\text{if } (DW > 0.0) \text{ then } \max(10^{(\log DW + 1.22)/2.37}, ML) \text{ else } 0.0)$$

Where

ML	= mantle length [mm]
DW	= Dry weight [mgC]

Mantle width (MW) was calculated using the relationship between ML and MW for *L. pealei* (comparable size with *L. opalescens*) reared in laboratory (Vecchione, 1981).

Rule 3.109 updates the mantle width:

### Rule 3.109

$$MW = ((0.38 ML) + 0.78)$$

Where

MW	= mantle width [mm]
ML	= mantle length [mm]
0.38	= coefficient [dimensionless]
0.78	= coefficient [mm]

Rule 3.110 updates the frontal surface area:

### Rule 3.110

$$S = (\text{PI } (MW/2)^2 \times 10^{-6})$$

Where

S	= frontal surface area visible from above [mm <sup>2</sup> ]
S $1 \times 10^{-6}$	= frontal surface area visible from above [m <sup>2</sup> ]
PI	= $\pi = 3.14$
MW	= mantle width [mm]

### 30. Update nitrogen pool

Rule 3.111 updates the potential nitrogen pool:

**Rule 3.111**

$$\text{Ammonium}_{\text{PoolTemp}} = (\text{Ammonium}_{\text{Pool}} + (\text{Ammonium}_{\text{Ingested}} - ((\text{CTimeStep}) + (\text{E}_{\text{protein}} \text{Q}_{\text{Nprot}} \text{TimeStep}))))$$

Where:

$\text{Ammonium}_{\text{PoolTemp}}$	= Nitrogen pool [mmol N]
$\text{Ammonium}_{\text{Pool}}$	= Nitrogen pool at the end of previous timestep [mmol N]
$\text{Ammonium}_{\text{Ingested}}$	= Nitrogen ingested [mmol N h <sup>-1</sup> ]
C	= N excretion rate [mmol N h <sup>-1</sup> ]
$\text{E}_{\text{protein}}$	= undigested protein [mmolC h <sup>-1</sup> ]
$\text{Q}_{\text{Nprot}}$	= 0.15 [mmol N mmolC <sup>-1</sup> ] nitrogen:carbon ratio in protein
TimeStep	= 0.5 [h]

Rule 3.112 updates the nitrogen pool:

**Rule 3.112**

$$\text{Ammonium}_{\text{Pool}} = (\text{if } (\text{Ammonium}_{\text{PoolTemp}} < (\text{Protein}_{\text{poolTemp}} \text{Q}_{\text{Nprot}})) \text{ then } \text{Ammonium}_{\text{PoolTemp}} \text{ else } (\text{Protein}_{\text{poolTemp}} \text{Q}_{\text{Nprot}}))$$

Where:

$\text{Ammonium}_{\text{Pool}}$	= Nitrogen pool after removal of excess nitrogen [mmol N]
$\text{Ammonium}_{\text{PoolTemp}}$	= Nitrogen pool [mmol N]
$\text{Protein}_{\text{PoolTemp}}$	= protein pool [mmol C]
$\text{Q}_{\text{Nprot}}$	= 0.15 [mmol N mmolC <sup>-1</sup> ] nitrogen:carbon ratio in protein

Rule 3.113 computes the nitrogen to carbon ratio:

**Rule 3.113**

$$\text{Q}_{\text{N}} = (\text{if } (\text{Carbon}_{\text{Pool}} > 0.0) \text{ then } \frac{\text{Ammonium}_{\text{Pool}}}{\text{Carbon}_{\text{Pool}}} \text{ else } 0.0)$$

Where:

$\text{Q}_{\text{N}}$	= nitrogen:carbon ratio [mmoN mmolC <sup>-1</sup> ]
$\text{Ammonium}_{\text{Pool}}$	= nitrogen pool after removal of excess nitrogen [mmol N]
$\text{Carbon}_{\text{Pool}}$	= carbon pool [mmol C]

Rule 3.114 computes N excretion in case of protein catabolism:

**Rule 3.114**

$$\text{NProt}_{\text{excess}} = (\text{if } (\text{Ammonium}_{\text{PoolTemp}} > (\text{Protein}_{\text{poolTemp}} \text{Q}_{\text{Nprot}})) \text{ then } (\text{Ammonium}_{\text{PoolTemp}} - (\text{Protein}_{\text{poolTemp}} \text{Q}_{\text{Nprot}})) 0.0)$$

Where

$\text{NProt}_{\text{excess}}$	= nitrogen above the nitrogen to protein ratio [mmol N]
$\text{Ammonium}_{\text{PoolTemp}}$	= nitrogen pool [mmol N]
$\text{Protein}_{\text{PoolTemp}}$	= protein pool [mmol C]
$\text{Q}_{\text{Nprot}}$	= 0.15 [mmol N mmolC <sup>-1</sup> ] nitrogen:carbon ratio in protein

### 31. Mortality due to starvation

A squid dies of starvation when its carbon pool falls below 3/4 of its previously achieved maximum carbon pool  $C_{pmax}$ , or when it has been ingesting less than 10% of its  $Carbon_{pool}$  per day for more than three days.

Rule 3.115 defines mortality by carbon starvation:

<b>Rule 3.115</b>	
	if ( $Carbon_{pool} \leq (3/4 C_{pmax})$ ) or ( $Days_{unfed} \geq 3$ ) then change(Dead)
<i>where:</i>	
$C_{pmax}$	= maximum carbon pool obtained [mmol C]
$Carbon_{pool}$	= carbon pool [mmol C]
$Days_{unfed}$	= number of days of sub-optimal feeding [d]
change	= VEW function (see VEW 3.3 Handbook)

Rule 3.116 records the maximum obtained carbon pool:

<b>Rule 3.116</b>	
	$C_{pmax} = (if (Carbon_{pool} > C_{pmax}) then Carbon_{pool} else C_{pmax})$
<i>where:</i>	
$C_{pmax}$	= maximum carbon pool attained [mmol C]
$Carbon_{pool}$	= carbon pool [mmol C]
$Days_{unfed}$	= number of days of sub-optimal feeding [d]
change	= VEW function (see Handbook)

---

### From the literature on mortality

La Roe (1971) suggests that squid die of starvation if their daily feeding rate falls below 10% body weight for 3 days, or if their carbon pool falls below three quarters of the maximum achieved.

### 32. Remineralisation of corpses

Rule 3.117 computes the nitrogen remineralisation rate:

**Rule 3.117**

$$R_{NT} = 4.2 \times 10^{-3} \cdot 2.95^{((Temp + 273) - 283)/10}$$

where:

- $R_{NT}$  = Nitrogen remineralisation rate [ $\text{mmol N h}^{-1}$ ]
- $4.2 \times 10^{-3}$  =  $N_{\text{dissolution}}$  [ $\text{mmol N mmol N}^{-1} \text{ h}^{-1}$ ] N specific dissolution rate of N
- 2.95 =  $Q_{\text{RemN}}$  [dimensionless] factor to link N dissolution with T
- Temp = ambient temperature [ $^{\circ}\text{C}$ ]
- Temp + 273 = temperature [ $^{\circ}\text{K}$ ]
- 283 = [ $^{\circ}\text{K}$ ] reference temperature

Rule 3.118 defines the release of nitrogen:

**Rule 3.118**

$$\text{release}(\max((\text{Ammonium}_{\text{Pool}} R_{NT} \text{ TimeStep}), 0.0), \text{Ammonium}_{\text{Conc}})$$

where:

- release = VEW function (see VEW 3.3 Handbook)
- $\text{Ammonium}_{\text{Conc}}$  = dissolved nitrogen concentration [ $\text{mmol N m}^{-3}$ ]
- $\text{Ammonium}_{\text{Pool}}$  = nitrogen pool after removal of excess nitrogen [ $\text{mmol N}$ ]
- $R_{NT}$  = nitrogen remineralisation rate [ $\text{mmol N h}^{-1}$ ]
- TimeStep = 0.5 [h]

Rule 3.119 updates the nitrogen pool in the corpse:

**Rule 3.119**

$$\text{Ammonium}_{\text{Pool}} = \max((\text{Ammonium}_{\text{Pool}} - (\text{Ammonium}_{\text{Pool}} R_{NT} \text{ TimeStep})), 0.0)$$

where:

- $\text{Ammonium}_{\text{Pool}}$  = Nitrogen pool after removal of excess nitrogen [ $\text{mmol N}$ ]
- $R_{NT}$  = Nitrogen remineralisation rate [ $\text{mmol N h}^{-1}$ ]
- TimeStep = 0.5 [h]

### 33. Excretion

Nitrogen is excreted as a liquid in the form of ammonia, whenever proteins are used to cover metabolic costs or when the ratio of nitrogen to protein is exceeded. Ammonia excretion is a continuous linear process over short periods of time.

Rule 3.120 defines the excretion of ammonia when proteins are used to cover metabolic costs:

<i>Rule 3.120</i>	
$C = (\min (C_{N\_Pool} , \frac{\text{respiration}}{(E_{n\_prot} C_{conv2})} Q_{N\_prot} Q_{PL\_used}))$	
<i>where:</i>	
C	= Ammonium excretion rate [mmol N h <sup>-1</sup> ]
C <sub>conv2</sub>	= 0.012 [gC mmolC <sup>-1</sup> ] mmol C to gC conversion factor
C <sub>Npool</sub>	= protein pool [mmol C]
E <sub>nprot</sub>	= energy content in squid protein [cal gC <sup>-1</sup> ]
Q <sub>N_prot</sub>	= 0.15 [mmol N mmolC <sup>-1</sup> ] N:C ratio in protein
Q <sub>PL_used</sub>	= 0 [dimensionless] proportion of protein-lipid used for metabolism
respiration	= total metabolic cost [cal h <sup>-1</sup> ]

Rule 3.121 adds the excreted ammonia to ambient dissolved N concentration:

<i>Rule 3.121</i>	
$\text{release } (((C \text{TimeStep}) + N_{\text{Prot}_{\text{Excess}}}), \text{Ammonium}_{\text{conc}})$	
<i>where:</i>	
release	= VEW function (see VEW 3.3 Handbook)
Ammonium <sub>conc</sub>	= dissolved nitrogen concentration [mmolN m <sup>-3</sup> ]
C	= ammonium excretion rate [mmolN h <sup>-1</sup> ]
N <sub>Prot<sub>excess</sub></sub>	= nitrogen above the nitrogen to protein ratio [mmol N]
TimeStep	= 0.5 [h]

Rule 3.122 adds the silicate ingested to ambient dissolved Si concentration:

<i>Rule 3.122</i>	
$\text{release } (\text{Silicate}_{\text{Ingested}} , \text{Silicate}_{\text{conc}})$	
<i>where:</i>	
release	= VEW function (see VEW 3.3 Handbook)
Silicate <sub>Ingested</sub>	= Silicon ingested [mmol Si h <sup>-1</sup> ]
Silicate <sub>conc</sub>	= dissolved silicate concentration [mmol N m <sup>-3</sup> ]

---

### From the literature on excretion

Lee (1994) suggests that protein is used for energy, and the excretion of ammonia is 2-3 times higher than for fishes of similar body weight, because of the high content of protein compared to lipids in squids.

### 34. Egestion

Unassimilated lipids and proteins are egested as a faecal pellet every time step. Nitrogen is egested in pellets as a fixed ratio of protein egested ( $Q_{Nprot} = 0.15 \text{ mmol N mmolC}^{-1}$ ).

Rule 3.123 to compute the egestion of unassimilated proteins as faecal pellets:

<b>Rule 3.123</b>	
create (Pellet ,1)	
Carbon <sub>Pool</sub>	$= (\text{Carbon}_{\text{Ingested}} - (\text{C}_{\text{NIngested}} + \text{C}_{\text{NNIngested}}) + (\text{E}_{\text{lipid}} + \text{E}_{\text{protein}} + \text{Lip}_{\text{excess}}))$
Ammonium <sub>Pool</sub>	$= \text{E}_{\text{protein}} Q_{Nprot} \text{ TimeStep}$
<i>where:</i>	
create	= VEW function (see Handbook)
Ammonium <sub>Pool</sub>	= Nitrogen pool [mmol N]
Carbon <sub>Ingested</sub>	= Carbon ingested [mmol C h <sup>-1</sup> ]
Carbon <sub>Pool</sub>	= Carbon pool [mmol C]
C <sub>NIngested</sub>	= Protein ingested [mmol C h <sup>-1</sup> ]
C <sub>NNIngested</sub>	= Lipid ingested [mmol C h <sup>-1</sup> ]
E <sub>lipid</sub>	= Protein not assimilated [mmol C h <sup>-1</sup> ]
E <sub>protein</sub>	= Protein not assimilated [mmol C h <sup>-1</sup> ]
Lip <sub>excess</sub>	= lipid above maximum lipid pool /DW ratio [dimensionless]
Q <sub>Nprot</sub>	= 0.15 [mmol N mmolC <sup>-1</sup> ]
TimeStep	= 0.5 [h] timestep

---

#### From the literature on egestion

The proportion of digested protein and lipid that is not assimilated is egested as a faecal pellet (O'Dor and Wells, 1987).

---

#### Parameters values in the literature

Q<sub>Nprot</sub> = 0.15 [mmol N mmolC<sup>-1</sup>]  
From Lee (1994)



### 35. Pellet sinking

Fæcal pellets are assumed to sink at a constant rate of  $10 \text{ m h}^{-1}$ . As a fæcal pellet sinks through the mesocosm, it remineralises nitrogen as a function of its nitrogen content and ambient temperature.

Rule 3.124 to compute the depth of fæcal pellets:

**Rule 3.124**

$$z = (\text{if } (z < \text{MLDepth}) \text{ then } (\text{MLDepth}) + 10 \text{TimeStep} \text{ ) else } (z + 10 \text{TimeStep}))$$

where:

$z$	= depth in at the end of previous timestep [m]
MLDepth	= depth of the turbocline [m]
TimeStep	= 0.5 [h]
10	= [ $\text{m h}^{-1}$ ] sinking speed

### 36. Pellet remineralisation

As a pellet sink it is remineralised by an implicit bacteria population, following the same rule rule used in LERM for copepods. The rate of pellets remineralisation is temperature dependent (Heath et al, 1997).

Rule 3.125 computes the nitrogen remineralisation rate of a pellet:

<b>Rule 3.125</b>	
	$R_{NTPellet} = (4.2 \times 10^{-3} \cdot 2.95^{((Temp + 273) - 283)/10})$
<i>where:</i>	
$R_{NTPellet}$	= Nitrogen remineralisation rate [mmol N h <sup>-1</sup> ]
$4.2 \times 10^{-3}$	= [mmol N mmolN <sup>-1</sup> h <sup>-1</sup> ] N specific dissolution rate of N
2.95	= [dimensionless] factor to link N dissolution with T
Temp	= ambient temperature [°C]
Temp + 273	= temperature [°K]
283	= [°K] reference temperature

Rule 3.126 defines the release of remineralised nitrogen in the water:

<b>Rule 3.126</b>	
	release ((Ammonium <sub>Pool</sub> R <sub>NTPellet</sub> TimeStep), Ammonium <sub>conc</sub> )
<i>where:</i>	
release	= VEW function (see VEW 3.3 Handbook)
Ammonium <sub>conc</sub>	= dissolved nitrogen concentration [mmolN m <sup>-3</sup> ]
Ammonium <sub>Pool</sub>	= nitrogen pool after removal of excess nitrogen [mmol N]
R <sub>NTPellet</sub>	= nitrogen remineralisation rate [mmolN h <sup>-1</sup> ]
TimeStep	= 0.5 [h]

Rule 3.127 updates the nitrogen pool in the pellet:

<b>Rule 3.127</b>	
	Ammonium <sub>Pool</sub> = max((Ammonium <sub>Pool</sub> - (Ammonium <sub>Pool</sub> R <sub>NTPellet</sub> TimeStep)), 0.0)
<i>where:</i>	
Ammonium <sub>Pool</sub>	= nitrogen pool of pellet [mmolN]
R <sub>NTPellet</sub>	= nitrogen remineralisation rate [mmolN h <sup>-1</sup> ]
TimeStep	= 0.5 [h] t

Rule 3.128 sets the carbon pool in the pellet to zero:

<b>Rule 3.128</b>	
	Carbon <sub>Pool</sub> = 0.0
<i>where:</i>	
Carbon <sub>Pool</sub>	= Carbon pool of pellet [mmol C]

### 37. Metamorphosis from $S_j$ to $S_{(j+1)}$

Squid are divided into 1mm size classes of mantle length (tab.3.2). Once its mantle length reaches the threshold, the squid moves into the next size class. Although squid growth is continuous and not staged (as for copepods), this “staged growth” of squid is used to compute the change in size and therefore visibility of a squid from their predator perspective.

Rule 3.129 summarises “metamorphosis” from one size class to the next one for all stages  $S_1$  to  $S_7$  (recruits):

*Rule 3.129*

*For squid in stage  $S_j$*

*if  $(ML \geq S_{(j+1)_{ML}})$  then change( $S_{j+1}$ )*

*where:*

ML	= mantle length [mm]
$S_j$	= generic squid stage $S_j$
$S_{(j+1)}$	= generic squid stage following from $S_j$
$S_{(i+1)_{ML}}$	= minimum ML for moving into stage $S_{j+1}$ [mm] listed in tab.3.1

---

### From the literature on metamorphosis

Squid fed *ad libitum* reaches a ML of about 8 mm in 40 days. This is the same time when *L. opalescens* switches from a diet based on copepods to a diet composed on mysid and shrimp larvae up to 10 mm long (Yang *et al.*, 1983).

Observations on laboratory reared *L. opalescens* revealed that the squid mastery of copepod capture develops progressively. The attack speed increases in proportion to ML, and culminates in adult-like prey capture behaviour at about 40 days post-hatching (Chen *et al.*, 1996).

### 38. Recruits N release

The purpose of rule 3.130 is to ensure that the preservation of the chemical budget of the virtual ecosystem (i.e. the chemicals contained in recruited squid which leave the mesocosm are released in the mesocosm).

Rule 3.130 releases the recruits particulate N to the water:

**Rule 3.130**

release ((Ammonium<sub>Pool</sub> + Nitrate<sub>Pool</sub> + Ammonium<sub>Ingested</sub> + Nitrate<sub>Ingested</sub>),  
Ammonium<sub>conc</sub>)

*where:*

release	= VEW function (see VEW 3.3 Handbook)
Ammonium <sub>conc</sub>	= dissolved nitrogen concentration [mmol N m <sup>-3</sup> ]
Ammonium <sub>Ingested</sub>	= Ammonium ingested [mmol N h <sup>-1</sup> ]
Ammonium <sub>Pool</sub>	= Nitrogen pool [mmol N]
Nitrate <sub>Ingested</sub>	= Nitrate ingested [mmol N h <sup>-1</sup> ]
Nitrate <sub>Pool</sub>	= Nitrate pool [mmol N] Set to zero

*This rule is applied only to recruited squid*

Rule 3.131 sets the nitrogen pool in the recruited squid to zero:

**Rule 3.131**

Ammonium<sub>Pool</sub> = 0.0

*where:*

Ammonium <sub>Pool</sub>	= Nitrogen pool [mmol N]
--------------------------	--------------------------

Rule 3.121 sets the nitrate pool in the recruited squid to zero:

**Rule 3.132**

Nitrate<sub>Pool</sub> = 0.0

*where:*

Nitrate <sub>Pool</sub>	= Nitrate pool [mmol N]
-------------------------	-------------------------

Rule 3.133 releases the recruits particulate Si to the water:

**Rule 3.133**

release (Silicate<sub>Ingested</sub>, Silicate<sub>conc</sub>)

*where:*

release	= VEW function (see Handbook)
Silicate <sub>Ingested</sub>	= silicate ingested [mmol Si h <sup>-1</sup> ]
Silicate <sub>conc</sub>	= dissolved silicate concentration [mmol Si m <sup>-3</sup> ]

### 39. N adjustment

$N_{\text{adjuster}}$  is a pseudo-stage of squid created to keep track of the N added for the N pool of immigrant squid at hatching.  $N_{\text{adjuster}}$  is kept at  $z = 450\text{m}$  in rule 3.26. Squid are initialized at hatching with N pool in excess to the chemical budget of the virtual ecosystem. When the squid are recruited the excess N is returned to a depth  $> 450\text{m}$ .

Rule 3.134

<i>Rule 3.134</i>	
	If ( $\text{Excess}_N > 0.0$ ), uptake( $\text{Excess}_N$ , Ammonium <sub>conc</sub> )
<i>where:</i>	
uptake	= VEW function (see VEW 3.3 Handbook)
$\text{Excess}_N$	= N added by squid injection
Ammonium <sub>ingested</sub>	= ammonium ingested [ $\text{mmol N h}^{-1}$ ]
Ammonium <sub>conc</sub>	= dissolved nitrogen concentration [ $\text{mmol N m}^{-3}$ ]

Rule 3.135:

<i>Rule 3.135</i>	
	$\text{Excess}_N = (\text{Excess}_N - \text{Ammonium}_{\text{ingested}})$
<i>where:</i>	
$\text{Excess}_N$	= N added by squid injection
Ammonium <sub>ingested</sub>	= ammonium ingested [ $\text{mmol N h}^{-1}$ ] by $N_{\text{adjuster}}$ (rule 3.134)

Rule 3.136 updates the depth of the  $N_{\text{adjuster}}$ :

<i>Rule 3.136</i>	
	$z = (z + 1)$
<i>where:</i>	
$z$	= depth [m]

#### **40. Recruitment annual reset**

Rule 3.137 remove the recruited squid (S7) and reset the annual number of recruits:

**Rule 3.137**

if ( $d_{\text{year}} > 240$ ), change(S13)

where:

$d_{\text{year}}$  = day number since the 1<sup>st</sup> Jan

change = VEW function (see VEW 3.3 Handbook)

S13 = inactive stage

## PART 4 – Top Predators

### CONTENT

<b>Design considerations .....</b>	<b>208</b>
Computer agents for top predators .....	208
Predation .....	208
Feeding .....	208
Top predator growth .....	208
Top predator excretion and egestion .....	208
Demography .....	209
Top predator motility .....	209
Trophic closure .....	209
<b>Overview of Top Predators .....</b>	<b>211</b>
<b>Exogenous rules for Top Predator (s) .....</b>	<b>213</b>
1. Total concentration of TP (s) .....	213
2. Vertical distribution of TP(s) .....	213
3. Size of TP(s) .....	214
<b>Endogenous rules for TP(s) .....</b>	<b>215</b>
4. Ingestion for TP(s) .....	215
5. Egestion for TP(s) .....	219
6. Pellet sinking for TP(s) .....	220
7. Remineralisation for TP(s) .....	221
<b>Exogenous rules for Top Predator (c) .....</b>	<b>222</b>
1. Total concentration of TP(c) .....	222
2. Vertical distribution of TP(c) .....	222
3. Size of TP(c) .....	222
<b>Endogenous rules for TP(c) .....</b>	<b>223</b>
4. Ingestion for TP(c) .....	223
5. Egestion for TP(c) .....	226
6. Pellet sinking for TP(c) .....	226
7. Remineralisation for TP(c) .....	227

## **Design considerations**

The top predators in LERM represent the first application of a new approach to trophic closure in Lagrangian Ensemble models. The design is based on two ideas: (1) endogenous predation and (2) exogenous demography, growth and behaviour.

LERM features two populations of top predators. One is a functional group that feeds visually on the squid. The other is a functional group that feeds non-visually on the copepods.

### **Computer agents for top predators**

LERM allocates one computer agent per (one-metre thick) layer of the virtual mesocosm to each of the functional groups.

Every individual top predator in the virtual ecosystem is a member of a sub-population associated with one or other of the set computer agents for its functional group.

### **Predation**

Predation by an individual top predator is computed using phenotypic rules in the same way as it is computed for individual zooplankters in the explicit populations (copepods and squid in LERM).

An individual top predator is a carnivorous plankter that preys on its prey zooplankton, which occurs in explicit populations. It depletes its prey population in the usual way for Lagrangian Ensemble virtual ecosystems. That is the role of the top predators. That is how trophic closure acts in LERM.

### **Feeding**

The top predators that feed on squid use vision to find its prey. The efficiency depends on the visibility of the planktonic squid.

The top predators that feed on copepods do not use vision to find its prey. They represent all the non-visual feeders that eat copepods.

### **Top predator growth**

An individual top predator ingests its prey according to (endogenous) phenotypic equations like those used for the squid (see Part 3). However, the rate of uptake of carbon from the ingested prey does not determine the growth of the top predator. That is specified by an exogenous equation.

### **Top predator excretion and egestion**

A top predator excretes ammonium and egests carbon and nitrogen in faecal pellets just as these functions are performed by the explicit population of squids. The carbon and nitrogen in the TP faecal pellets are remineralized in the same way as squid and copepod faecal pellets. The total masses of ingested carbon and nitrogen are returned to solution every time step. That is how LERM achieves trophic closure of chemicals.



## Demography

The vertically-integrated number of top predators in each population is computed using exogenous equations. It is not an emergent property of the virtual ecosystem.

## Top predator motility

The computer agents do not move. So LERM does not represent the diel migration and foraging behaviour of top predators. VEW 3.3 supports diel and seasonal variation in the concentration profile of top predators. It does that by means of exogenous equations that specify how the vertical distribution of top predator number concentration varies with time. That facility is not used in LERM. So the top predators do not have exogenously driven diel and seasonal migration and foraging.

## Trophic closure

Trophic closure of plankton ecosystem models poses a challenging problem. It is extremely important, because it controls the trophic cascade, which lies at the heart of modelling for ecosystem-based fisheries management. LERM adopts a new procedure for trophic closure designed by John Woods to replace that used in the WB model. Before describing the Woods closure scheme it will be helpful to describe two earlier methods that it replaces. These are due to Steele & Henderson (1995; SH closure) and Woods and Barkmann (1994; WB closure).

### *Steele-Henderson trophic closure*

This was introduced for the population-based metamodel. It provides trophic closure by adding a loss term to the demographic equation for the population of zooplankton at the highest trophic level (herbivores in NPZD models). The loss term is proportional to the square of the number of those zooplankton. So SH closure focuses on the prey, not the predator. If the ingestion rate is assumed to be proportional to the concentration of prey, then the SH closure implies that the number of predators linearly related to the prey concentration. That has some plausibility. But SH closure makes no statement about the top predators that are eating the zooplankton. It is mathematically convenient, but biologically bereft. Nevertheless it has been widely adopted in plankton ecology modelling. One final point about SH closure: Caswell and Neubert (1998) have pointed out that introducing a quadratic loss term in the equation for zooplankton demography can be the cause of chaotic instability. It would be nice to avoid that risk, and to make the closure more biological.

### *Woods-Barkmann trophic closure*

This was introduced to add biology and avoid instability. It was designed for individual-based models integrated by the Lagrangian Ensemble (LE) metamodel. So the loss term attributable to top predators was applied to an individual zooplankton, the prey of a top predator. The loss term computed the risk of the prey zooplankton being eaten by a top predator. In LE integration, the loss of individuals from an agent's sub-population is proportional to that risk. Woods, Perilli and Barkmann (2005) showed that this ergodic assumption was accurate to a few percent in the WB model. Trophic closure in WB

models assumed that the top predators used vision to find their prey. Their rate of success was proportional to the visibility of an individual prey zooplankter. This was equated to the cross-section area of the prey and its ambient irradiance in the spectral band of the light used by the predator to find its prey. This method replaced the troublesome quadratic loss term in SH closure by a term that had some biological meaning, namely visual predation. Its principal weaknesses were that the implicit size and concentration of top predators; they were assumed to be uniform in depth and constant in time. Those weaknesses were eliminated in the new Woods-Sinerchia parametrization, which was first used in LERM. The new method opened the door to a detailed investigation of the trophic cascade in LERM virtual ecosystems (Woods, Sinerchia & Vallerga 2008).

#### *Woods-Sinerchia trophic closure*

This new method of trophic closure was designed for individual-based models integrated by the Lagrangian Ensemble metamodel. It introduces for the first time a semi-explicit population of top predators. They are described as semi-explicit, because some properties are endogenous and others are exogenous.

The endogenous properties are biological functions like ingestion and gut processes. They are described by phenotypic rules like those used to model the corresponding biological functions in the explicit zooplankton (copepods and squid paralarvae in LERM).

There are three exogenous properties: (1) the size of an individual, (2) their total number and (3) their distribution with depth. In top predators, temporal changes in these three properties are not computed from phenotypic rules. They are computed from exogenous equations and parameters. Trophic closure is determined by the specifications for these exogenous equations and parameters. Decoupling the endogenous biology from the exogenous demography and migration avoids the risk of chaotic instability found in Steel-Henderson trophic closure. The user can design a top predator to represent known species, by using the endogenous (phenotypic) rules derived from marine biology and the exogenous (demographic) equations derived from biological oceanography.

The population of top predators is represented by a set of computer agents, each of which obeys the Lagrangian Ensemble metamodel. So each agent behaves like a single animal, and carries information about a dynamic sub-population of animals. In the case of top predators the agents do not move: the animals have no behaviour (i.e. they neither sink nor swim through the water). For reasons of computational economy, one top predator agents is allocated to each one-metre thick layer used to resolve the environment in the virtual mesocosm. The number of TPs in each agent's sub-population is determined by the exogenous equations.

The TPs prey on zooplankton. The prey in each layer of the mesocosm is computed by summing over the agent's residing in or passing through the layer during the time step. The total number of prey ingested by the top predators in that layer is computed from their ingestion rule. That number is removed *pro rata* from the sub-populations of the prey in the layer (or passing through).

## Overview of Top Predators

LERM uses the Woods-Sinerchia method of trophic closure. It features two populations of top predators, which feed on copepods and squid respectively. Each TP has a set of endogenous (phenotypic) rules for ingestion, and exogenous equations for TP size, number and vertical distribution.

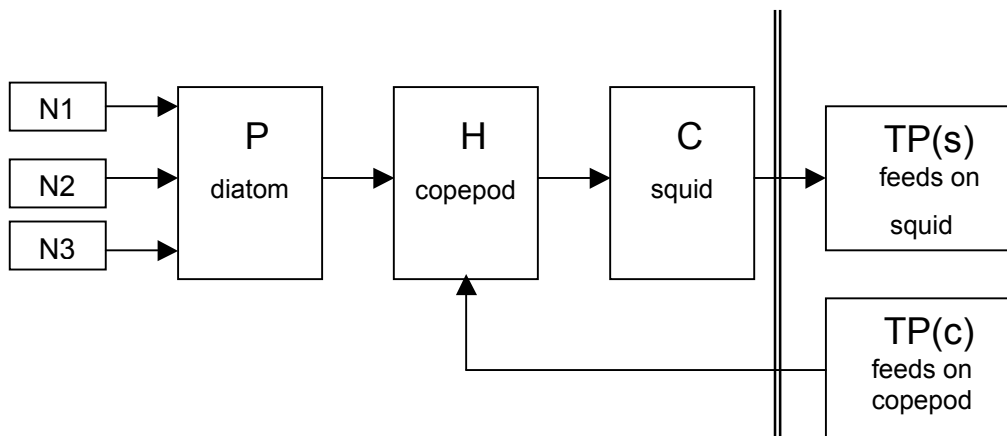

Fig. 4.1 LERM trophic cascade: N (nutrients: ammonia, nitrate, silicate); P (Phytoplankton based on diatom); H (herbivorous zooplankton based on copepod); C (Carnivorous zooplankton based on squid paralarvae); TP1 (Top predator feeding on C based on adult squid); TP2 (Top predator feeding on C).

### *Top predators feeding on copepods, TP(c)*

The first population of top predators, TP(c), prey on the copepods at a rate that depends on the predator size and concentration, and the prey concentration, as described by the endogenous (phenotypic) rule 4.6 and following ones. The exogenous equations keep the size, number and distribution of these top predators constant throughout the year.

### *Top predators feeding on squid, TP(s)*

The second population of top predators, TP(s), feed visually on the squid paralarvae at a rate that depends on the predator size and concentration, and on the prey visibility, as described by endogenous (phenotypic) rules 4.6. For simplicity, in each time step all the top predators are assumed to have the same mass, which increases progressively through the spring while their prey are present, according to the exogenous TP equation TP(s). The number of predators increases during the year according to TP(s) rule 4.1. They are distributed uniformly with depth, according to TP(s) rule 4.2.

Predator and prey interact only through ingestion. Top predators feed on prey, but are not affected by biological feedback from the virtual ecosystem.

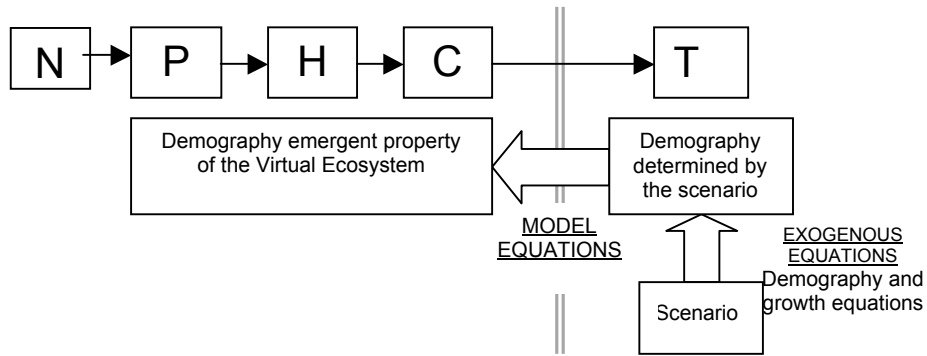

Fig.4.2 Top predators demography and interaction with prey.  
 N: Nutrients, P: Phytoplankton, H: Herbivores, C: Carnivores; TP: Top Predators

## Exogenous rules for Top Predator (s)

Exogenous equations defined in the scenario describe the demographic state of the predator population, in particular annual distribution, vertical distribution and growth rate.

### 1. Total concentration of TP (s)

LERM top predator TP(s) feeding on paralarvae of the squid *Loligo forbesii* represent a population of larger squid *Loligo forbesii*. TP(s) are present in the virtual ecosystem from the 1<sup>st</sup> April until ~1<sup>st</sup> August when they reach a mantle length of 40 mm ML.

The mortality rate of the predator population is assumed to follow a negative exponential function of the time of the year (Rule 4.1). Every year the concentration of TP(s) is set back to its initial value.

Rule 4.1 defines the annual distribution of TP(s):

#### Rule 4.1

$$N_t = ((\text{if } ((d_0 \leq d_{\text{year}}) \text{ and } (d_{\text{year}} < d_{\text{max}})) \text{ then } ((n_0 e^{-[(d_{\text{year}} - d_0)/d_{\text{star}}]}) \text{ else } 0) + N_{\text{back}})$$

where:

$N_t$  = vertically integrated concentration [TPs m<sup>-2</sup>]

$n_0$  = 3000 vertically integrated concentration at immigration [TP(s m<sup>-2</sup>)]

$d_0$  = 90 [day] of top predator immigration (= 1<sup>st</sup> April)

$d_{\text{max}}$  = 221 [day] of top predator emigration (= 10<sup>th</sup> August).

$d_{\text{star}}$  = 150 [day] e-folding time

$d_{\text{year}}$  = day of the year since 1<sup>st</sup> January [day]

---

### 2. Vertical distribution of TP(s)

The vertical distribution of TP(s) in the water column is assumed to be homogeneous in the top 100m.

Rule 4.2 defines the vertical distribution of TP(s):

#### Rule 4.2

$$D_t = (\text{if } (z < 100) \text{ then } 0.01 \text{ else } 0)$$

Where

$D_t$  = percentage of total population in each layer [dimensionless]

$z$  = depth [m]

### 3. Size of TP(s)

*Loligo forbesii* juveniles (15 mm ML) grow at a rate of 2% of its mantle length (ML) in its first months of life and feed on the explicit squid population until they reach 40 mm ML.

Rule 4.3 defines the mantle length at which TP(s) starts feeding on squid:

**Rule 4.3**

$$S_t = (\text{if } (d_0 < d_{\text{year}}) \text{ and } (d_{\text{year}} < d_{\text{max}}) \text{ then } (s_0 (p + 1)^{(d_{\text{year}} - d_0)}) \text{ else } 0)$$

**Where**

- $S_t$  = mantle length [mm]
- $d_0$  = 90 [day] of top predator immigration (= 1<sup>st</sup> April)
- $d_{\text{max}}$  = 221 [day] of top predator emigration (= 10<sup>th</sup> August)
- $d_{\text{year}}$  = day of the year since 1<sup>st</sup> January [day]
- $p$  = 0.02 ML [d<sup>-1</sup>] daily growth rate (currently 0.07)
- $s_0$  = 15 [mm] mantle length at immigration

## Endogenous rules for TP(s)

### 4. Ingestion for TP(s)

TP(s) feed on all squid stages, except emigrants, dead and pellets.

The maximum ingestion rate is a function of the weight of the predator and the weight of the prey.

Ingestion rate depends on the concentration and visibility of prey, hunting efficiency and ambient temperature

The visibility of the prey is determined by the ambient irradiance and by the cross-section area of the prey (fig.4.3).

The hunting efficiency of capture is modeled as the velocity of the prey (prey escape ability) in relation to the swiftness of the predator ( $W_{tg}$ ). Hunting efficiency is modelled as function of the ratio of squid ML and the stage-specific squid maximum swimming speed (Table 4.1).

Ingestion rate can never exceed maximum ingestion rate.

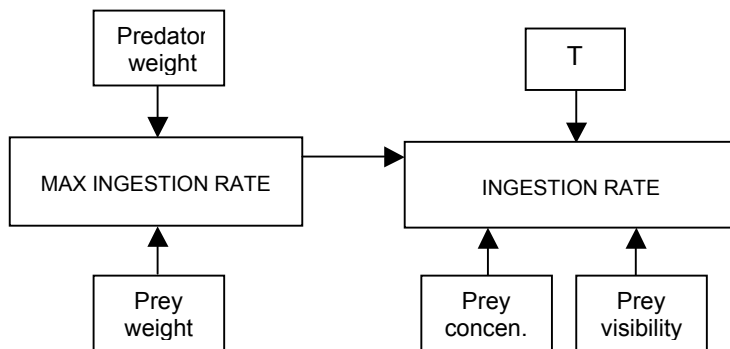

Fig. 4.3 Predator ingestion rate: internal and external controlling factors.

Rule 4.4 to convert mantle length  $S_t$  into predator weight  $G$  (Hurley, 1976):

**Rule 4.4**

$$G = (2.37 ((\log_{10}(S_t) - 1.22)) / 12$$

Where

- G = predator weight [mmol C]
- $S_t$  = mantle length [mm]
- 12 =  $C_{conv}$  [mg C mmol C<sup>-1</sup>] mmol C to mg C conversion factor

Rule 4.5 defines the swiftness of the predator  $W_{tg}$  for hunting efficiency:

**Rule 4.5**

$$W_{tg} = ((0.3 + (0.7 (Temp/T_{ref}))) \text{if } (S_t \geq S_{max}) \text{ then } 1 \text{ else } (S_t / S_{max}))$$

Where

$W_{tg}$	= effect of temperature and size on swimming [dimensionless]
$S_t$	= mantle length [mm]
$S_{max}$	= 40 [mm] mantle length
Temp	= ambient temperature [°C]
$T_{ref}$	= 10 [°C] Reference temperature

Rule 4.6 to define the stage specific ingestion rate,  $I_{gv}$ :

**Rule 4.6**

$$I_{gv} = \min ((W_{tg} \text{ if } (P > P_{minv}) \text{ then } k_p(S_a/1E-5)(Vis_{Irrad}/1)(P-P_{minv})^2/((P-P_{minv})+K_{iv}))(135/P_{speed}) \text{ else } 0), (G 0.6156e^{-((0.0321(d_{year}-d_0)))}) / (86400 P_{size}))$$

Where

$I_{gv}$	= stage specific ingestion rate [prey s <sup>-1</sup> ]
$W_{tg}$	= effect of temperature and size on swimming [dimensionless]
$K_p$	= predator hunting volume scan rate [m <sup>3</sup> s <sup>-1</sup> ]*
$S_a$	= stage specific surface area [m <sup>2</sup> see Table 4.1]*
1E-5	= $S_{aMax}$ maximum surface area for a stage 6 squid [m <sup>2</sup> ]
$I_r$	= ambient irradiance [Wm <sup>-2</sup> ]
1	= $I_{ref}$ [Wm <sup>-2</sup> ] reference irradiance
$P_{speed}$	= stage specific maximum swimming speed [mh <sup>-1</sup> ]*
135	= $P_{speedMax}$ [mh <sup>-1</sup> ] maximum swimming speed for a stage 6 squid
$P$	= stage specific ambient prey concentration [prey m <sup>-3</sup> ]
$P_{minv}$	= stage specific minimum ambient prey concentration [prey m <sup>-3</sup> ]
$K_{iv}$	= half-saturation constant [prey m <sup>-3</sup> ]
$0.6156e^{-[0.0321 \times (d_{year}-d_0)]}$	= 0–1 range of max percentage of predator carbon (G) that can be ingested per day by a predator since immigration ( $d_{year}-d_0$ ) (Koueta&Boucaud-Camou, 2001) see Fig.4.4.
G	= predator weight [mmol C]
$P_{size}$	= stage specific prey carbon content [mmolC prey <sup>-1</sup> ]
$d_0$	= 90 [day] of top predator immigration (= 1 <sup>st</sup> April)
$d_{year}$	= day of the year since 1 <sup>st</sup> January

\*the values of the parameters for each stage can be found in table 4.1 (page 218)



Rule 4.7 defines the ingestion rate  $I_g$  (for all stages):

<b>Rule 4.7</b>	
$I_g = \text{varietysum}(I_{gv})$	
<i>Where</i>	
$I_g$	= ingestion rate for all stages [ $\text{prey s}^{-1}$ ]
$I_{gv}$	= stage specific ingestion rate [ $\text{prey s}^{-1}$ ]
varietysum = VEW function (see Handbook)	

Rule 4.8 commands ingestion at the rate  $I_g$ :

<b>Rule 4.8</b>	
ingest ( $P, P_{\text{minv}}, I_g$ )	
<i>Where</i>	
$I_g$	= ingestion rate for all prey stages [ $\text{prey s}^{-1}$ ]
$P$	= stage specific ambient prey concentration [ $\text{prey m}^{-3}$ ]
$P_{\text{minv}}$	= stage specific minimum ambient prey concentration [ $\text{prey m}^{-3}$ ]
ingest = VEW function (see Handbook)	

Table 4.1 Stage-specific parameters of the prey of top predator TP(s)

Stage	ML size [mm]	$K_p$ [ $\text{m}^3\text{s}^{-1}$ ]	$P_{\text{size}}$ [mmol C]	$P_{\text{minv}}$ [prey $\text{m}^{-3}$ ]	$K_{iv}$ [prey $\text{m}^{-3}$ ]	$S_a$ m <sup>2</sup>	$P_{\text{speed}}$ m/h
S1	< 3	0.02	0.06	1	$10^5$	$2.8 \times 10^{-6}$	52
S2	3-4	0.02	0.10	1	$10^5$	$3.5 \times 10^{-6}$	63
S3	4-5	0.02	0.18	1	$10^5$	$4.9 \times 10^{-6}$	81
S4	5-6	0.02	0.29	1	$10^5$	$6.5 \times 10^{-6}$	99
S5	6-7	0.02	0.43	1	$10^5$	$8.3 \times 10^{-6}$	117
S6	7-8	0.02	0.60	1	$10^5$	$1.0 \times 10^{-5}$	135

## From the literature on ingestion

The maximum rate of ingestion is modelled as the maximum daily percentage of body weight that can be consumed (Koueta and Boucaud-Camou, 2001)

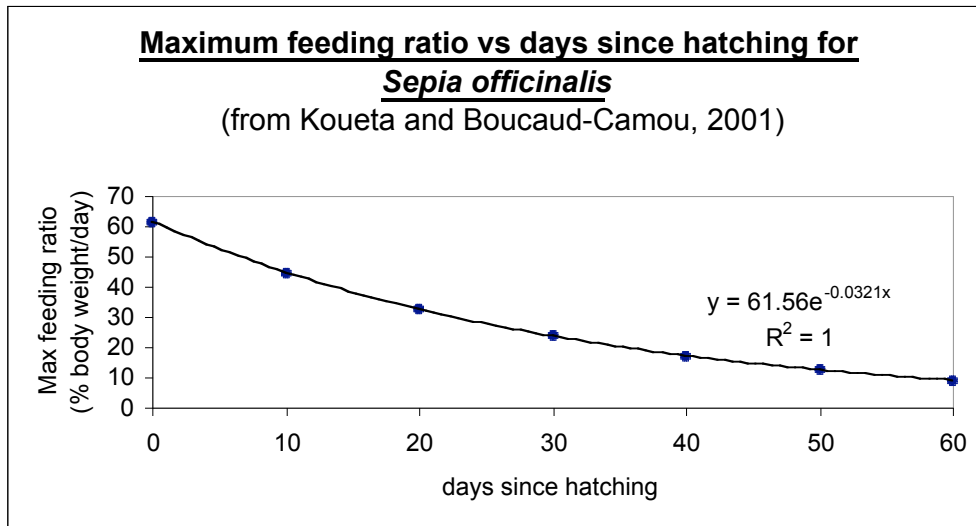

Fig.4.4 – Top predator maximum ingestion rate.

---

### Parameters values

$S_{aMax}$  =  $1 \times 10^{-5}$  [m<sup>2</sup>] maximum surface area for a stage 6 squid

$P_{speedMax}$  = 135 [mh<sup>-1</sup>] maximum swimming speed for a stage 6 squid

See table 4.1 for stage-specific parameters of the prey of TP(s).

## 5. Egestion for TP(s)

A pellet, containing all the nitrogen and carbon ingested, is released every timestep.

Rule 4.9 to compute the production of a faecal pellet:

<i>Rule 4.9</i>	
create (Pellet , 1)	
Ammonium <sub>Pool</sub>	= Ammonium <sub>Ingested</sub> + Nitrate <sub>Ingested</sub>
<i>where:</i>	
create	= VEW function (see Handbook)
Ammonium <sub>Pool</sub>	= Nitrogen pool [mmol N]
Ammonium <sub>Ingested</sub>	= Nitrogen ingested [mmol N h <sup>-1</sup> ]
Nitrate <sub>Ingested</sub>	= Nitrate ingested [mmol N h <sup>-1</sup> ]

Rule 4.10 adds the silicate ingested to the ambient dissolved Si concentration:

<i>Rule 4.10</i>	
release ( Silicate <sub>Ingested</sub> , Silicate <sub>conc</sub> )	
<i>where:</i>	
release	= VEW function (see Handbook)
Silicate <sub>Ingested</sub>	= Silicon ingested [mmol Si h <sup>-1</sup> ]
Silicate <sub>conc</sub>	= dissolved silicate concentration [mmol N m <sup>-3</sup> ]

## 6. Pellet sinking for TP(s)

A pellet, containing the nitrogen ingested, is released every timestep. As it sinks at a constant speed of 10 m/h, it is remineralised by an implicit bacteria population. Pellets remineralization is modeled as in copepods.

As a faecal pellet sinks through the mesocosm, it remineralises nitrogen as a function of its nitrogen content and ambient temperature.

Rule 4.11 to compute the depth of faecal pellets:

**Rule 4.11**

$$z = \text{if } (z < \text{MLDepth}) \text{ then } (\text{rnd}(\text{MLDepth}) + 5) \text{ else } (z + 5)$$

where:

$z$  = depth in at the end of previous timestep [m]

$\text{MLDepth}$  = depth of the turbocline [m]

5 = [m] displacement in 1 timestep of a pellet sinking at 10m/h

$\text{rnd}$  = function of the VEW see Handbook range (0 –  $\text{MLDepth}$ )

## 7. Remineralisation for TP(s)

Rule 4.12 computes the nitrogen remineralisation rate of a pellet:

<b>Rule 4.12</b>	
	$R_{nTPred} = (4.2E-3 \cdot 2.95^{((Temp + 273) - 283)/10})$
<i>where:</i>	
$R_{nTPred}$	= Nitrogen remineralisation rate [mmol N h <sup>-1</sup> ]
4.2E-3	= $N_{dissolution}$ [mmol N mmolN <sup>-1</sup> h <sup>-1</sup> ] N specific dissolution rate
2.95	= $Q_{RemN}$ [mmol N] factor to link N dissolution with T
Temp	= ambient temperature [°C]
(Temp + 273)	= temperature [°K]
$T_{Nref}$	= 283 [°K] reference temperature

Rule 4.13 adds the nitrogen remineralised to the ambient dissolved N concentration:

<b>Rule 4.13</b>	
	$\text{release}((\text{if}(\text{Ammonium}_{Pool} > 0) \text{ then } (\text{Ammonium}_{Pool} R_{nTPred} \text{ TimeStep})) \text{ else } 0), \text{Ammonium}_{conc})$
<i>where:</i>	
release	= VEW function (see Handbook)
$\text{Ammonium}_{Pool}$	= Nitrogen pool after removal of excess nitrogen [mmol N]
$R_{nTPred}$	= Nitrogen remineralisation rate [mmol N h <sup>-1</sup> ]
TimeStep	= 0.5 [h] timestep
$\text{Ammonium}_{conc}$	= dissolved nitrogen concentration [mmol N m <sup>-3</sup> ]

Rule 4.14 updates the nitrogen pool in the pellet:

<b>Rule 4.14</b>	
	$\text{Ammonium}_{Pool} = \max((\text{Ammonium}_{Pool} - (\text{Ammonium}_{Pool} R_{nTPred} \text{ TimeStep})), 0)$
<i>where:</i>	
$\text{Ammonium}_{Pool}$	= Nitrogen pool of pellet [mmol N]
$R_{nTPred}$	= Nitrogen remineralisation rate [mmol N h <sup>-1</sup> ]
TimeStep	= 0.5 [h] timestep

---

### From the literature on detritus

The rate of pellets remineralization is temperature dependent (Heath et al, 1997).

## Exogenous rules for Top Predator (c)

Exogenous equations defined in the scenario describe the demographic state of the predator population, in particular annual distribution, vertical distribution and growth rate.

### 1. Total concentration of TP(c)

TP(c) are present all year at a constant concentration of 3000 per m<sup>2</sup>, and they are homogeneously distributed in the top 100m of the water column. Every year the concentration of predators is set back to its initial value. The vertical distribution of TP(c) in the water column is assumed to be homogeneous in the top 100m.

Rule 4.15 defines the annual distribution of TP(c):

<i>Rule 4.15</i>	
	$N_t = 3000$
<i>where:</i>	
$N_t$	= vertically integrated concentration [ind m <sup>-2</sup> ]
$n_0$	= 3000 vertically integrated concentration at immigration [TP(s m <sup>-2</sup> )]

### 2. Vertical distribution of TP(c)

TP(c) are homogeneously distributed in the top 100m.

Rule 4.16 defines the vertical distribution of TP(c):

<i>Rule 4.16</i>	
	$D_t = (\text{if } (z < 100) \text{ then } 0.01 \text{ else } 0)$
<i>Where</i>	
$D_t$	= percentage of total population in each layer [dimensionless]
$z$	= depth [m]

### 3. Size of TP(c)

LERM top predator TP(c) feed on all copepod stages, but overwintering, corpses and pellets. Background top predators are assumed to maintain a constant size (40 mm).

Rule 4.17 defines the mantle length at which TP(c) starts feeding on copepod:

<i>Rule 4.17</i>	
	$S_t = s_0$
<i>Where</i>	
$S_t$	= mantle length [mm]
$s_0$	= 40 [mm] mantle length at immigration

## Endogenous rules for TP(c)

### 4. Ingestion for TP(c)

TP(c) predators feed on all copepod stages, but overwintering, dead and pellets. TP(c) are not visual predator.

The ingestion is calculated as the maximum daily percentage of body weight that can be consumed. As the weight of the predator is kept constant, maximum ingestion rate depends on the weight of the prey. The bigger the prey the less can be ingested by the predator, and vice versa. Ingestion rate is function of the ambient concentration of prey and temperature (fig.4.5). Ingestion rate can never exceed maximum ingestion rate.

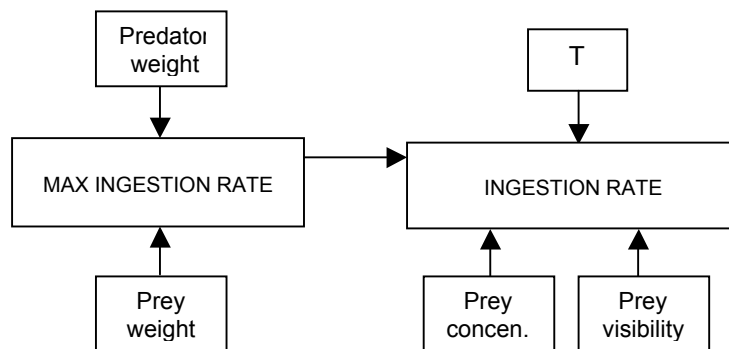

Fig. 4.5 Predator ingestion rate, internal and external controlling factors

As the size of the predator is constant, maximum percentage of C that can be ingested is reduced to a constant,  $I_{max40} = 6.0 \times 10^{-5} \text{ mmol C s}^{-1}$ .

This is divided by  $P_{size}$  = the stage specific prey carbon content [mmolC] to convert from  $\text{mmolC s}^{-1}$  to number of prey  $\text{s}^{-1}$  (table 4.2).

Rule 4.18 to define the stage specific ingestion rate,  $I_{gv}$ :

#### Rule 4.18

$$I_{gv} = \min \left( \left( (0.3 + (0.7 \cdot (\text{Temp}/T_{ref})) \cdot \text{if}(P > P_{minv}) \text{ then } ((P - P_{minv}) \cdot (P - P_{minv}) \cdot k_p / ((P - P_{minv}) + K_{iv})) \text{ else } 0.0) \right), (I_{max40} / P_{size}) \right)$$

#### Where

$I_{gv}$	= stage specific ingestion rate [ind $\text{s}^{-1}$ ]
$K_p$	= predator hunting volume scan rate [ $\text{m}^3 \text{s}^{-1}$ ]
$P$	= stage specific ambient prey concentration [ind $\text{m}^{-3}$ ]
$P_{minv}$	= stage specific minimum ambient prey concentration [ind $\text{m}^{-3}$ ]
$K_{iv}$	= half-saturation constant [ind $\text{m}^{-3}$ ]
Temp	= ambient temperature [ $^{\circ}\text{C}$ ]
$T_{ref}$	= reference temperature [ $^{\circ}\text{C}$ ]
$I_{max40}$	= $6.0 \times 10^{-5}$ [mmol C $\text{s}^{-1}$ ] maximum carbon ingestion rate
$P_{size}$	= stage specific prey carbon content [mmolC]

Rule 4.19 to computes the ingestion rate:

<b>Rule 4.19</b>	
	ingest (P, P <sub>minv</sub> , I <sub>g</sub> )
<i>Where</i>	
I <sub>g</sub>	= ingestion rate for all prey stages [prey s <sup>-1</sup> ]
P	= stage specific ambient prey concentration [prey m <sup>-3</sup> ]
P <sub>minv</sub>	= stage specific minimum ambient prey concentration [prey m <sup>-3</sup> ]
ingest	= VEW function (see Handbook)

Tab.4.2 – Top predator TP(c) stage-specific prey parameters:

Stage	Stage description	Kp	P <sub>size</sub> [mmol C]	P <sub>min</sub> [prey/m <sup>3</sup> ]	k <sub>iv</sub> [prey/m <sup>3</sup> ]	S <sub>a</sub> [m <sup>2</sup> ]	P <sub>speed</sub> [m/h]
JN3	Nauplius III	10 <sup>-3</sup>	1.00x10 <sup>-5</sup>	1000	10 <sup>6</sup>	1.46x10 <sup>-8</sup>	5.09
N4	Nauplius IV	10 <sup>-3</sup>	1.70x10 <sup>-5</sup>	1000	10 <sup>6</sup>	1.70x10 <sup>-8</sup>	5.93
N5	Nauplius V	10 <sup>-3</sup>	2.50x10 <sup>-5</sup>	1000	10 <sup>6</sup>	1.94x10 <sup>-8</sup>	6.77
N6	Nauplius VI	10 <sup>-3</sup>	3.75x10 <sup>-5</sup>	1000	10 <sup>6</sup>	2.22x10 <sup>-8</sup>	7.74
C1	Copepodite I	10 <sup>-3</sup>	6.25x10 <sup>-5</sup>	1000	10 <sup>6</sup>	2.62x10 <sup>-8</sup>	9.14
C2	Copepodite II	10 <sup>-3</sup>	9.20x10 <sup>-5</sup>	1000	10 <sup>6</sup>	2.97x10 <sup>-8</sup>	10.36
C3	Copepodite III	10 <sup>-3</sup>	2.10x10 <sup>-4</sup>	1000	10 <sup>6</sup>	3.88x10 <sup>-8</sup>	13.53
POW4	Pre-overwintering CIV	10 <sup>-3</sup>	5.83x10 <sup>-4</sup>	1000	10 <sup>6</sup>	5.42x10 <sup>-8</sup>	18.91
POW5	Pre-overwintering CV	10 <sup>-3</sup>	1.25x10 <sup>-3</sup>	1000	10 <sup>6</sup>	6.95x10 <sup>-8</sup>	24.24
OWD4	Overwintering descent CIV	10 <sup>-3</sup>	5.83x10 <sup>-4</sup>	1000	10 <sup>6</sup>	5.42x10 <sup>-8</sup>	18.91
OWD5	Overwintering descent CV	10 <sup>-3</sup>	1.25x10 <sup>-3</sup>	1000	10 <sup>6</sup>	6.95x10 <sup>-8</sup>	24.24
OWA4	Overwintering ascent CIV	10 <sup>-3</sup>	5.83x10 <sup>-4</sup>	1000	10 <sup>6</sup>	5.42x10 <sup>-8</sup>	18.91
OWA5	Overwintering ascent CV	10 <sup>-3</sup>	1.25x10 <sup>-3</sup>	1000	10 <sup>6</sup>	6.95x10 <sup>-8</sup>	24.24
C4	Copepodite IV	10 <sup>-3</sup>	5.83x10 <sup>-4</sup>	1000	10 <sup>6</sup>	5.42x10 <sup>-8</sup>	18.91
C4OW	Copepodite IV after OW	10 <sup>-3</sup>	5.83x10 <sup>-4</sup>	1000	10 <sup>6</sup>	5.42x10 <sup>-8</sup>	18.91
C5	Copepodite V	10 <sup>-3</sup>	1.25x10 <sup>-3</sup>	1000	10 <sup>6</sup>	6.95x10 <sup>-8</sup>	24.24
C6	Copepodite VI	10 <sup>-3</sup>	3.33x10 <sup>-3</sup>	1000	10 <sup>6</sup>	9.56x10 <sup>-8</sup>	33.35
Ad	Adult	10 <sup>-3</sup>	7.50x10 <sup>-3</sup>	1000	10 <sup>6</sup>	1.25x10 <sup>-7</sup>	43.60
Ma	Mature	10 <sup>-3</sup>	8.33x10 <sup>-3</sup>	1000	10 <sup>6</sup>	1.29x10 <sup>-7</sup>	45.00
Se	Senescent	10 <sup>-3</sup>	8.33x10 <sup>-3</sup>	1000	10 <sup>6</sup>	1.29x10 <sup>-7</sup>	45.00



## From the literature on ingestion

The maximum rate of ingestion is modelled as the maximum daily percentage of body weight that can be consumed (Koueta and Boucaud-Camou, 2001)

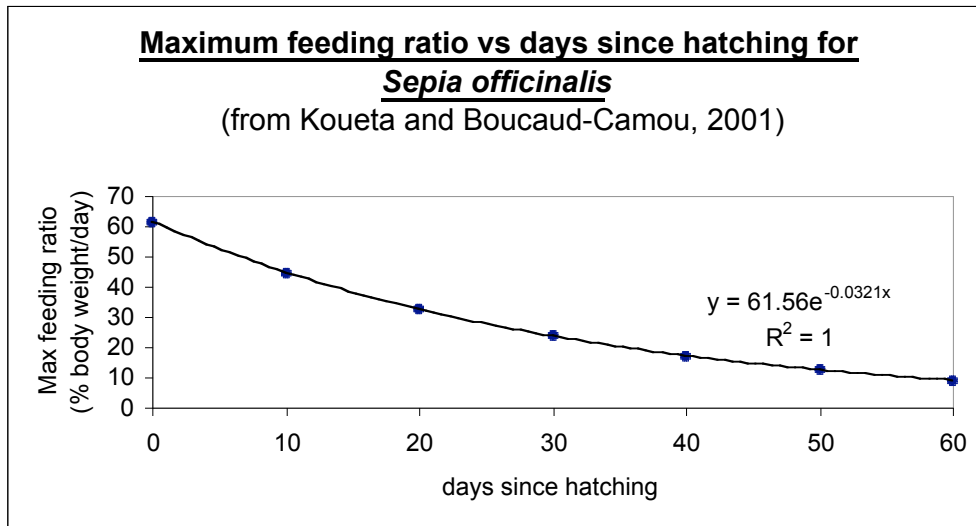

Fig.4.5 – Top predator maximum ingestion rate.

---

### *Parameters values in the literature*

$I_{max_{40}} = 6.0 \cdot 10^{-5} \text{ mmol C s}^{-1}$ .

## 5. Egestion for TP(c)

Rule 4.20 to compute the production of a faecal pellet:

<i>Rule 4.20</i>	
create (Pellet ,1)	
Ammonium <sub>Pool</sub>	= (Ammonium <sub>Ingested</sub> + Nitrate <sub>Ingested</sub> )
<i>where:</i>	
create	= VEW function (see Handbook)
Ammonium <sub>Pool</sub>	= Nitrogen pool [mmol N]
Ammonium <sub>Ingested</sub>	= Nitrogen ingested [mmol N h <sup>-1</sup> ]
Nitrate <sub>Ingested</sub>	= Nitrate ingested [mmol N h <sup>-1</sup> ]

Rule 4.21 adds the silicate ingested to the ambient dissolved Si concentration:

<i>Rule 4.21</i>	
release ( Silicate <sub>Ingested</sub> , Silicate <sub>conc</sub> )	
<i>where:</i>	
release	= VEW function (see Handbook)
Silicate <sub>Ingested</sub>	= silicate ingested [mmol Si h <sup>-1</sup> ]
Silicate <sub>conc</sub>	= dissolved silicate concentration [mmol N m <sup>-3</sup> ]

---

## 6. Pellet sinking for TP(c)

Faecal pellets are produced, sink and get remineralised in exactly the same way as for visual top predators. A pellet, containing all the nitrogen and carbon ingested, is released every timestep. As it sinks at a constant speed of 10 m/h, it is remineralised by an implicit bacteria population. Pellets remineralization is modeled as in copepods.

Rule 4.22 to compute the depth of faecal pellets:

<i>Rule 4.22</i>	
z = (if (z < MLDepth) then (rnd(MLDepth) + 5) else (z + 5))	
<i>where:</i>	
z	= depth in at the end of previous timestep [m]
MLDepth	= depth of the turbocline [m]
5	= [m] displacement in 1 timestep of a pellet sinking at 10m/h
rnd =	function of the VEW see Handbook range (0 – MLDepth)

## 7. Remineralisation for TP(c)

Rule 4.23 computes the nitrogen remineralisation rate of a pellet:

**Rule 4.23**

$$R_{nTBP} = N_{dissolution} Q_{RemN}^{((Temp + 273) - T_{Nref})/10}$$

where:

- $R_{nTBP}$  = Nitrogen remineralisation rate [mmol N h<sup>-1</sup>]
- 4.2E-3 =  $N_{dissolution}$  [mmol N mmolN<sup>-1</sup> h<sup>-1</sup>] N specific dissolution rate
- 2.95 =  $Q_{RemN}$  [mmolN] factor to link N dissolution with T
- Temp = ambient temperature [°C]
- Temp + 273 = temperature [°K]
- 283 = [°K] reference temperature

Rule 4.24 adds the nitrogen remineralised to the ambient dissolved N concentration:

**Rule 4.24**

$$\text{release}((\text{if}(\text{Ammonium}_{Pool} > 0)\text{then} (\text{Ammonium}_{Pool} R_{nTBP} \text{TimeStep})) \text{else} 0), \text{Ammonium}_{conc})$$

where:

- release = VEW function (see Handbook)
- $\text{Ammonium}_{conc}$  = dissolved nitrogen concentration [mmol N m<sup>-3</sup>]
- $\text{Ammonium}_{Pool}$  = Nitrogen pool after removal of excess nitrogen [mmol N]
- $R_{nTBP}$  = Nitrogen remineralisation rate [mmol N h<sup>-1</sup>]
- TimeStep = 0.5 [h]

Rule 4.25 updates the nitrogen pool in the pellet:

**Rule 4.25**

$$\text{Ammonium}_{Pool} = \max((\text{Ammonium}_{Pool} - (\text{Ammonium}_{Pool} R_{nTBP} \text{TimeStep})), 0.0)$$

where:

- $\text{Ammonium}_{Pool}$  = Nitrogen pool of pellet [mmol N]
- $R_{nTBP}$  = Nitrogen remineralisation rate [mmol N h<sup>-1</sup>]
- TimeStep = 0.5 [h] timestep